

CROOZER CARGO **OWNER'S MANUAL**

IMPRINT

Published by:
Croozer GmbH
An der Hasenkaule 10
50354 Hürth
Germany

Copyright © 2022 Croozer GmbH. All rights reserved.
No part of this manual may be reproduced or transmitted in any form
for any purpose other than the purchaser's personal use.

Additional manuals and instructions on the use of this product can be
ordered from Croozer GmbH or downloaded from the website www.croozer.com. Every effort has been made to ensure the accuracy of
this manual.

However, if you do find an error, we would appreciate hearing about it
so that we can correct it.

Planning, text, graphic design and editing:
W. Piontek, www.technik-transparent.de
Photos: W. Piontek and Croozer GmbH

Table of Contents

Description	2	Cleaning, Maintaining and Storing	
What's what?	2	the Croozer Cargo	26
2-in-1 System	3	How do I clean and maintain my Croozer Cargo?	26
What is the Croozer Cargo?	4	How do I store my Croozer Cargo?	26
How should the Croozer Cargo be used?	4	Preparing the Croozer Cargo for disposal	27
How shouldn't the Croozer Cargo be used?	4	Technical Data	28
Orientation and wording	4	Tested for Safety	28
Applicable standards	4	EU Declaration of Conformity and	
Safety Guidelines	5	Warranty	29
Symbols and warnings	5	EU Declaration of Conformity	29
Read and observe this manual.	5	Warranty	29
Who can ride the towing bicycle?	5	Dealers.	30
Requirements for the towing bicycle	5	Accessories	31
Legal requirements for using a bicycle trailer	5		
Before your first ride	5		
Pulling the Croozer Cargo Safely as a Trailer	5		
Riding over kerbs or uneven surfaces	6		
The Croozer Cargo as a Handcart (accessory)	6		
Usage, storage and transport	6		
Assembly, maintenance and repair	6		
Notice pursuant to Battery Act	6		
Initial Assembly and Unfolding the			
Croozer Cargo	8		
Checking package contents	8		
Unfolding the Croozer Cargo.	9		
Attaching the cover.	10		
Attaching and removing the wheels	10		
Preparing the Croozer Cargo for Use			
as a Bicycle Trailer	11		
Installing and removing the hitch arm	11		
Installing the axle hitch to the towing bicycle.	12		
Installing the safety flag	15		
Using Your Croozer Cargo	16		
Transporting cargo	16		
Opening, closing and removing the cover	17		
Hitching the Croozer to the towing bicycle	18		
Unhitching the Croozer from the towing bicycle	19		
Special considerations when riding with the bicycle trailer	20		
Special features of the Croozer Cargo Tuure suspension system.	20		
Transporting Your Croozer Cargo	23		
Croozer Cargo Inspections and			
Maintenance.	24		
Inspection intervals	24		
Service intervals	24		
Inspecting the hitch arm, hitch connector and hitch	25		
Inspect the fabric body	25		
Inspecting and servicing the side wheels	25		
Checking tyre pressure and treads.	25		
Servicing the lock cylinder on the hitch connector	25		
Cleaning and lubricating the wheel axles	25		
Inspecting the Croozer after an accident.	26		

Description

Description

What's what?

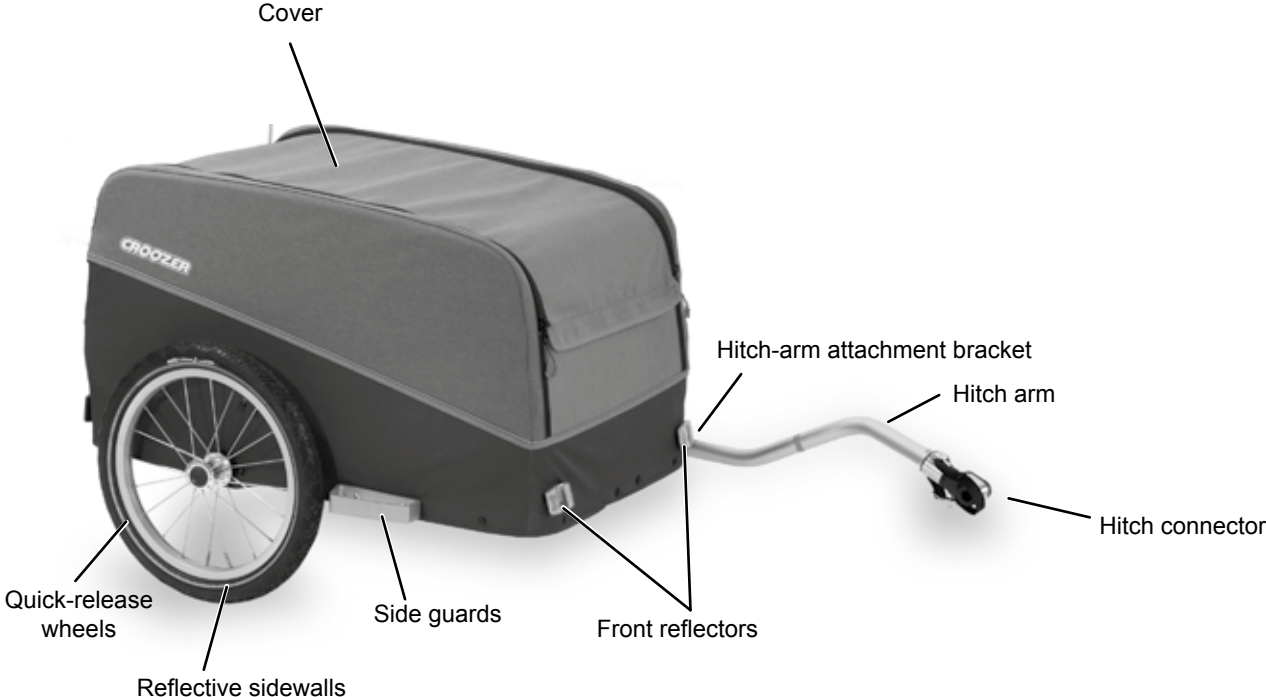

Maintenance-free AirPad® suspension with Sylomer® (Cargo Tuure)

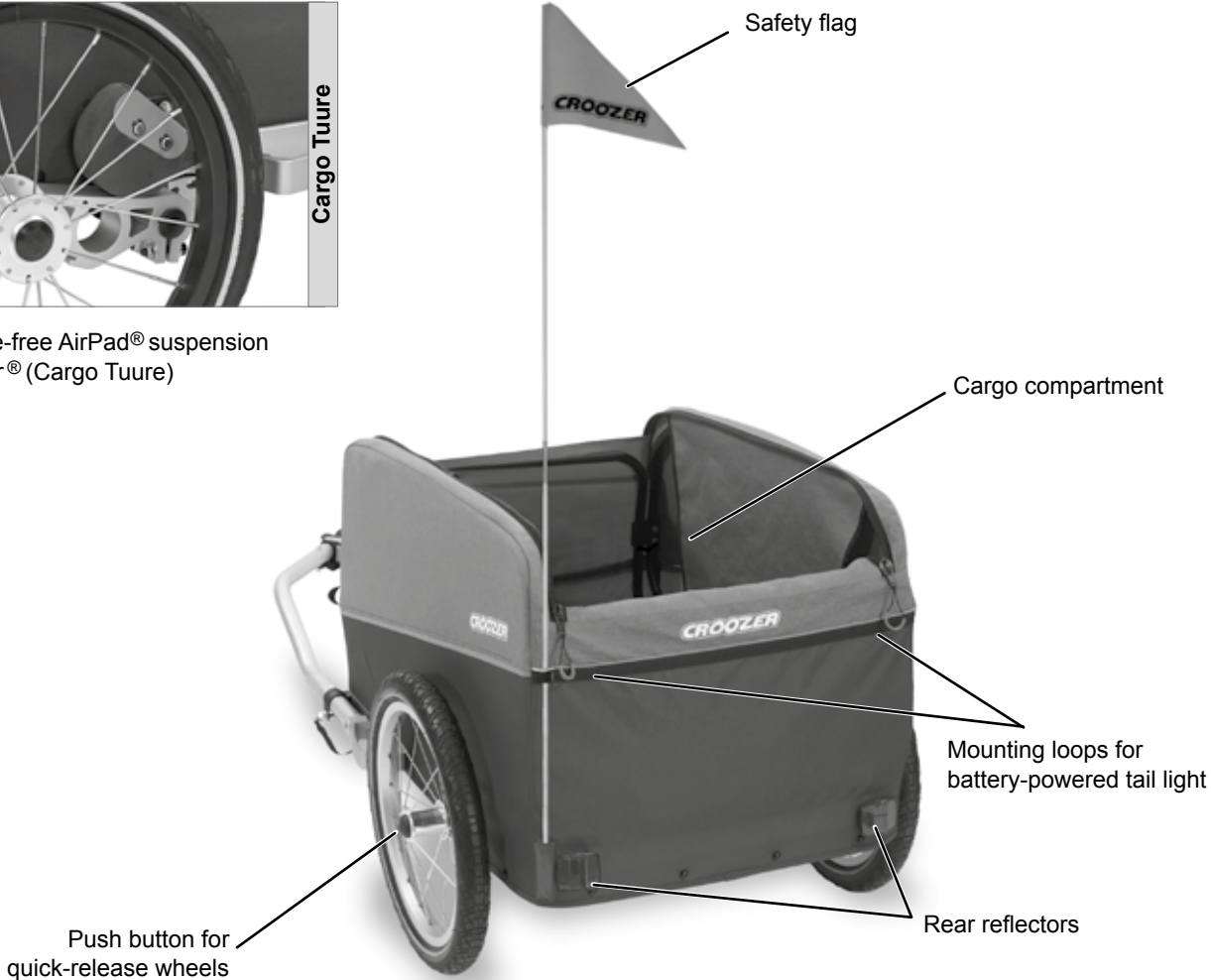

2-in-1 System

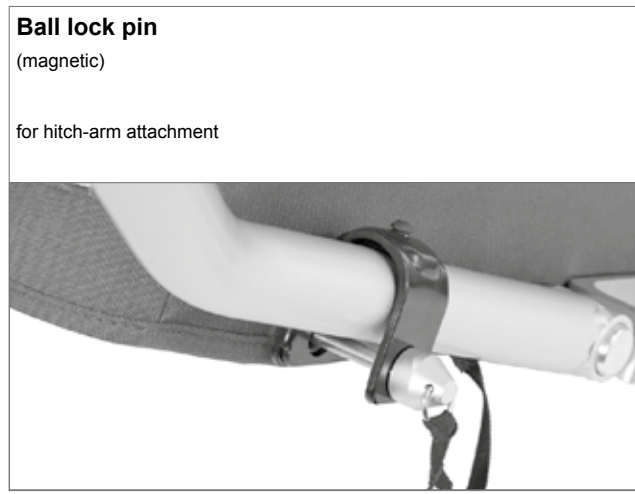
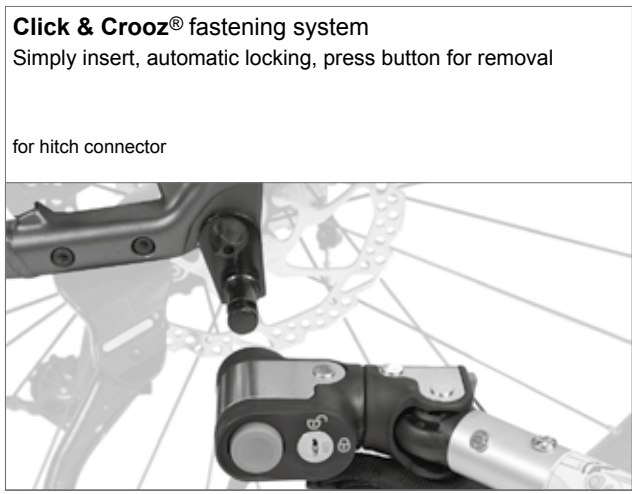
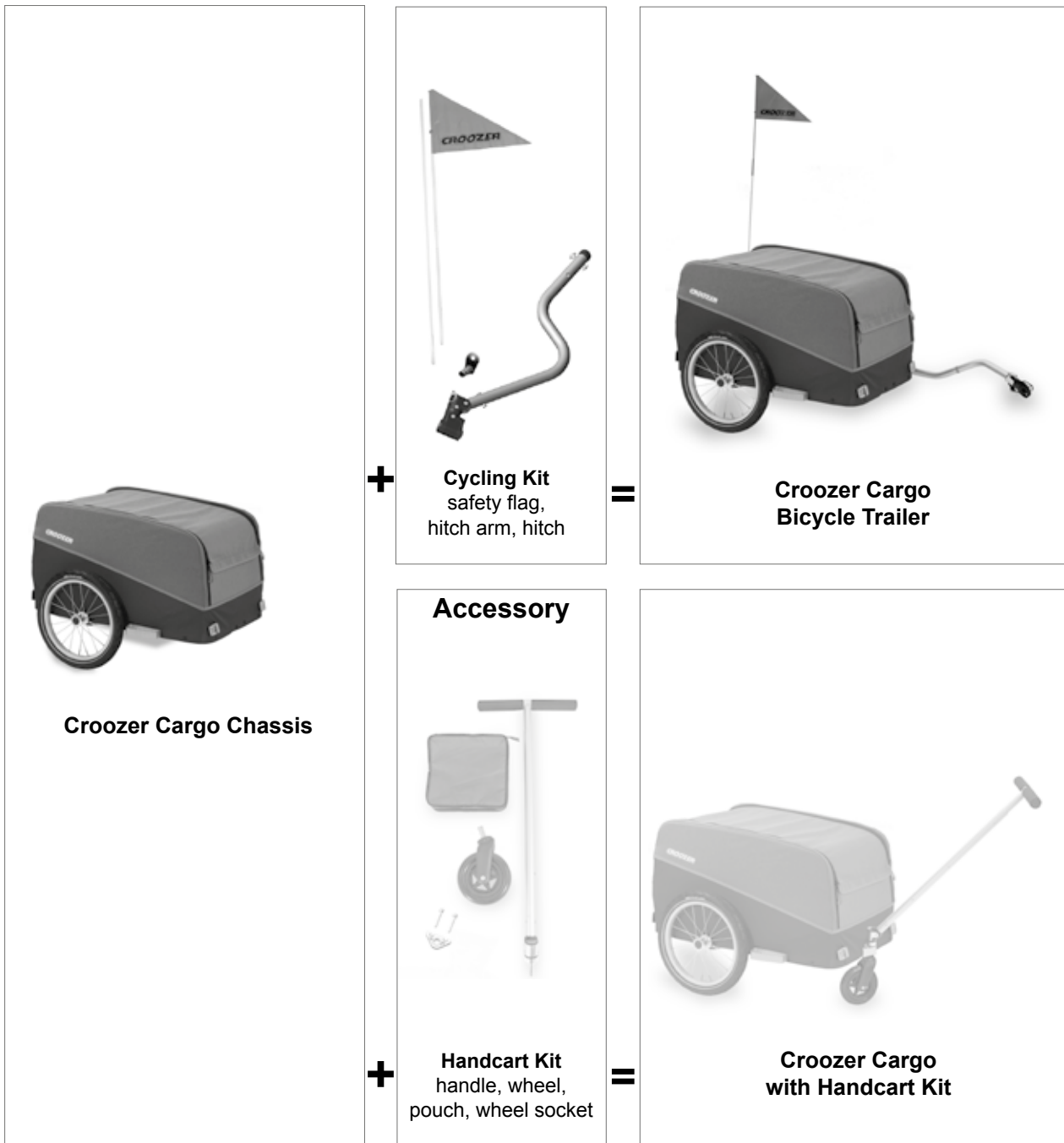

Description

What is the Croozer Cargo?

The Croozer Cargo is a bicycle trailer for transporting cargo. With the Handcart Kit (accessory), the Croozer Cargo can be quickly and easily converted to a Handcart.

How should the Croozer Cargo be used?

The Croozer Cargo is intended for private use for carrying cargo in daylight hours on roads and other smooth, well-surfaced paths as a Cargo Trailer or, with the Handcart Kit (available as an accessory), as a Handcart. The instructions and safety guidelines provided in this manual must be followed at all times. Offroad use is not permitted.

Maximum Weight of Loaded Trailer (Trailer + Cargo)	60 kg (132 lb)
Maximum Load* (Cargo)	45 kg (99 lb)
Hitch-Arm Load (Nose Weight)	3 to 11 kg (6.6 – 24.3 lb)
* Weight limits only apply if the hitch-arm load is within the specified range of 3 to 11 kg (6.6 – 24.3 lb). See page 16.	

When in use as a Cargo Trailer in poor visibility conditions or at night, dusk or dawn, the Croozer Cargo must be equipped with a lighting system that complies with the applicable laws and regulations in the country of use. A battery-powered tail light can be mounted to a loop on the rear cover. Any spare parts and accessories used for the Croozer Cargo must be approved by Croozer GmbH and properly installed, ideally by a professional bicycle mechanic.

How shouldn't the Croozer Cargo be used?

The Croozer Cargo may not be used in any manner other than as specified above. Never transport children or animals in the Croozer Cargo. Never use the Handcart (accessory) for jogging or skating. Commercial use, overloading, excessive speeds (of more than 25 km/h, or 15 mph, when in use as a Cargo Trailer, more than a walking speed when making tight turns or more than a walking speed when in use as a Handcart), improper repairs and use on unsurfaced roads or paths are not permitted.

Never pull the Croozer Cargo with a motorised vehicle, such as a moped or scooter. This also applies to motorised bicycles with a maximum speed of more than 25 km/h (15 mph). Do not mount the hitch to a bicycle with a rear-wheel hub motor, unless this modification is approved by the manufacturer. Croozer GmbH will not be liable for any damages resulting from non-compliance with these requirements.

Orientation and wording

Unless otherwise indicated, the terms right and left in this manual are relative to the direction of travel.

The descriptions given in this manual apply equally to the Croozer Cargo models Kalle, Pakko and Tuure. However, for the sake of clarity, only the Croozer Cargo Pakko is shown in the photos and graphics.

In sections that apply equally to all three models, the name "Croozer Cargo" is used for simplicity. In sections where the models differ, the instructions and/or information for the individual models are given separately and marked as follows:

Cargo Pakko

Cargo Kalle

Cargo Tuure

Applicable standards

The following standards were taken into consideration: DIN EN 15918:2017-05

Safety Guidelines

Symbols and warnings



DANGER!

DANGER indicates a hazardous situation which, if not avoided, will result in death or serious injury.



WARNING!

WARNING indicates a hazardous situation which, if not avoided, could result in death or serious injury.



CAUTION!

CAUTION indicates a hazardous situation which, if not avoided, could result in minor or moderate injury.

NOTICE

NOTICE indicates a situation which, if not avoided, could result in damage to the Croozer Cargo or the environment.

Tip: In this manual, "Tip" indicates helpful advice about the use or maintenance of the Croozer Cargo.

Read and observe this manual

This manual contains information that is extremely important for your safety and that of other road users. Therefore, it is essential that you read the entire manual carefully and follow the instructions closely. If you should experience difficulties understanding any of the information or instructions, please contact your Croozer dealer. Keep this manual handy at all times for future reference. If you loan or sell your Croozer Cargo, pass on this manual to the new user. It is also vitally important that you read and observe the instructions provided in the manual of the towing bicycle.

Who can ride the towing bicycle?

Be sure to familiarise yourself with the legal requirements in the country or state where you will be using the Croozer Cargo.

Requirements for the towing bicycle

The towing bicycle must be approved by its manufacturer for pulling a trailer. This information can be found in the owner's manual of the bicycle. Furthermore, the towing bicycle must be in perfect working order and have strong, properly functioning brakes. Keep in mind that braking distance is increased when pulling a bicycle trailer. Motorised vehicles may not be used for pulling bicycle trailers. The only exception to this rule is a pedelec. This special type of e-bicycle has an electric motor that delivers assist only when the rider pedals. In many countries, pedelecs legally qualify as bicycles. Electric bicycles with a maximum speed of more than 45 km/h (28 mph) are officially classified as mopeds in some countries and, as such, are often not allowed to pull bicycle trailers. The towing bicycle should be equipped with a sturdy rear-mount kickstand to ensure safety when loading and unloading the trailer.

Be sure to familiarise yourself with the legal requirements that apply to towing bicycles in the country or state where you will be using the Croozer Cargo.

The towing bicycle must have a 26" to 29" (559- to 635-mm) rear wheel. This information can be found on the tyre sidewalls. The numbers 42-622, for example, indicate that the tyre has a width of 42 mm and a bead-seat diameter of 622 mm (28 inches).

Legal requirements for using a bicycle trailer

Be sure to familiarise yourself with the legal requirements for pulling bicycle trailers in the country or state where you will be using the Croozer Cargo.

Before your first ride ...

It is vitally important that you familiarise yourself with the Croozer Cargo before you use it for transporting cargo. Prior to your first trip on public roads, Croozer GmbH recommends taking a practice ride in a calm, traffic-free area. This is a great way to become acquainted with the handling of the bicycle and the dimensions of the trailer.

Pinching hazard

When folding and unfolding the Croozer, keep fingers and hands clear of all possible pinch points (e.g. movable frame parts and locking mechanisms).

Pulling the Croozer Cargo Safely as a Trailer

Before each ride, check the following:

- Are the wheels securely attached (page 10)?
- Are the locking mechanisms for the unfolded frame properly engaged (page 9)?
- Is the hitch arm properly attached and secured? Is the trailer properly hitched to the towing bicycle and secured with the safety strap? Are all security pins correctly inserted and secured? Check that none of the security pins are hanging freely from their straps.
- Are the tyres inflated to the recommended pressure? The actual tyre pressure should never be higher or lower than the maximum and minimum inflation pressures marked on the tyre sidewall. (See also page 25). Never use compressed air, e.g. from a gas/petrol station, to fill your tyres. The rapid airflow and high pressure can over-inflate the tyres, causing the tube and/or tyre to burst.

Turning

Always reduce your speed to a walking pace when making turns with the bicycle trailer. Keep in mind that riding speed is often underestimated, especially on bikes with electric assist (i.e. pedelecs). When turning at high speeds, the increased centrifugal force could cause the bicycle trailer to skid or tip over, which can result in accidents with serious injury or death.

Riding downhill

Always reduce your speed when riding downhill. Riding at excessive speeds could cause the trailer to skid, which can result in accidents with serious injury or death.

Safety Guidelines

Riding over kerbs or uneven surfaces

Riding over a kerb or other obstacle with only one wheel of the trailer could propel the respective wheel off the ground and cause the trailer to tip over, potentially resulting in accidents with serious injury or death. Empty trailers and trailers with light loads are especially susceptible to tipping. Therefore, if you have to ride over a kerb or similar obstacle, always use extreme caution and ride at very low speeds. Never use the trailer on stairs or escalators.

Being visible to others

Never use your Croozer as a Cargo Trailer in road traffic without its safety flag mounted. The safety flag makes it easier for other road users to see you.

If you plan to use the Croozer as a bicycle trailer at night, dusk or dawn – or when visibility is in any way reduced – the trailer must be equipped with a fully functional lighting system. Be sure to acquaint yourself with the applicable laws in the state, country or region where you plan to use the trailer.

Carrying cargo

Be sure to properly secure all cargo in the trailer to prevent it from sliding or shifting, which could impair your riding safety. Never transport objects that are too large to fit completely into the cargo area of the trailer. Never attach cargo, such as bags or panniers, to the outside of the trailer. Cargo attached to the outside of the Croozer Cargo can drastically affect its handling and stability, potentially resulting in accidents with serious injury or death. You can carry smaller objects in the pocket inside the trailer.

The Croozer Cargo as a Handcart (accessory)

The Croozer Cargo with the Handcart Kit (accessory) is not approved for jogging or skating. Pulling the Handcart faster than a walking pace is not permitted.

Usage, storage and transport

Never transport the Croozer Cargo – even when folded – on the roof of a motor vehicle, as this could damage the fabric body.

Never use or store the Croozer Cargo at temperatures below -20°C (-4°F).

Assembly, maintenance and repair

Purchased condition and initial assembly

If you have purchased the Croozer Cargo from a shop, the dealer should have installed the axle hitch to the towing bicycle. If you ordered your Croozer from an online or mail-order catalogue, we recommend having the initial assembly performed by a professional bicycle mechanic. Furthermore, dealers are required to provide their customers with all important information on the use of the Croozer Cargo. To find an authorised dealer in your area, visit the Croozer website at croozer.com.

Technical condition

Never use the Croozer Cargo if it is not in perfect working order. The Croozer Cargo must be periodically inspected for damage and/or wear to the wheels, hitch arm, frame, fabric body, security pins and axle hitch. If any of these parts are found to be damaged, the Croozer Cargo may not be used until the damage has been properly repaired, ideally by a professional bicycle mechanic.

It is critical that all maintenance work specified in this manual be performed in the specified intervals.

Using the Croozer when it is not in perfect working order can result in accidents with serious injury or death.

Proper installation and repair

The Croozer Cargo must be properly assembled to professional standards. Follow the instructions for the correct installation of the axle hitch, hitch arm and Handcart Kit (accessory). When in doubt, contact your Croozer dealer. All repairs must be carried out to professional standards using only original Croozer parts, ideally by a professional bicycle mechanic. Incorrect installation or repair work could result in accidents with serious injury or death.

Suitable accessories and original spare parts

Only use accessories and original spare parts that have been recommended and approved by Croozer GmbH. These are the only components that can be used safely with the Croozer Cargo. When in doubt, consult a Croozer dealer. The use of non-approved accessories or incompatible spare parts could result in accidents with serious injury or death. Croozer GmbH will not be liable for any damage resulting from the use of non-approved accessories or incompatible spare parts.

Changes and modifications

For safety reasons, no modifications or changes can be made to the Croozer Cargo.

Do not install additional components, such as luggage racks etc. Do not install electric drive systems. Making modifications or changes to your Croozer can result in accidents with serious injury or death. Furthermore, changes or modifications to the vehicle will void any warranty claims. Croozer GmbH will not be liable for damages of any kind resulting from changes or modifications that have been made to the Croozer Cargo.

Notice pursuant to Battery Act

The lighting systems used by our trailers are equipped with disposable or rechargeable batteries. In accordance with the German Battery Act, we are required to inform you, as a consumer, that disposable and rechargeable batteries are to be collected and recycled separately from household waste. You can return used batteries to a municipal collection point or to a local retailer. Batteries that contain hazardous substances are marked with a crossed dust-bin and the chemical symbol (Cd, Hg or Pb) of the heavy metal that is considered harmful.

Initial Assembly and Unfolding the Croozer Cargo

If you have purchased the Croozer Cargo from a shop, the dealer should have installed the axle hitch to the towing bicycle and sold the Croozer "ready to use". If you ordered your Croozer from an online or mail-order catalogue, we recommend having the initial assembly performed by a professional bicycle mechanic. Furthermore, dealers are required to provide their customers with all important information on the use of the Croozer Cargo. If the initial assembly has been performed, you can skip the first few steps of this section.

If your Croozer Cargo was not assembled prior to sale, then have the initial assembly performed by a professional bicycle mechanic or follow the assembly instructions below. No tools are required for the assembly. A pair of diagonal cutting pliers will be needed for cutting the cable ties that are used to brace the frame of the new Croozer.



WARNING!

The Croozer Cargo must be properly assembled to professional standards. Improper assembly can result in accidents with serious injury or death.

Checking package contents

The Croozer Cargo is packaged in a box for shipment. In order to minimise package size, the Croozer Cargo is shipped in its folded state (1). All of the removable parts are packed inside the Croozer Cargo.

1. Take the folded Croozer Cargo out of the box and remove all packaging materials from the Croozer and individual parts. Recycle all packaging materials if possible. It may be wise to keep the box, e.g. for storage or later transport.
2. Using a pair of diagonal cutting pliers or other cutting tool, cut the cable ties with which the frame of the Croozer Cargo is secured and other parts are prevented from shifting.
3. Unfold the Croozer, and remove all individual parts from inside the Cargo Trailer. These parts include the side wheels (2),

Tip: *The models Pakko and Tuure are packaged with both wheels inside the trailer, and the model Kalle is packaged with one wheel inside the trailer and the second attached under the floor of the trailer.*

- the hitch arm with axle hitch (3) and three keys,
 - a safety flag (4)
 - and this owner's manual (5).
4. Remove all packaging materials from the individual parts and recycle if possible. It may be wise to keep the box, e.g. for storage or later transport.



Unfolding the Croozer Cargo

1. Place the folded Cargo Trailer on a clean and stable surface.
2. Pull the two side panels (1) apart and, if necessary, reposition the fabric over the frame tubes so that the zippers face inwards and run parallel to each other.
3. Pull the rear frame tube (2) towards the back and press it into the clips (3) on both sides until you hear and feel it snap into place.
4. Pull the front frame tube (4) forwards and press it into the clips (5) until you hear and feel it snap into place.

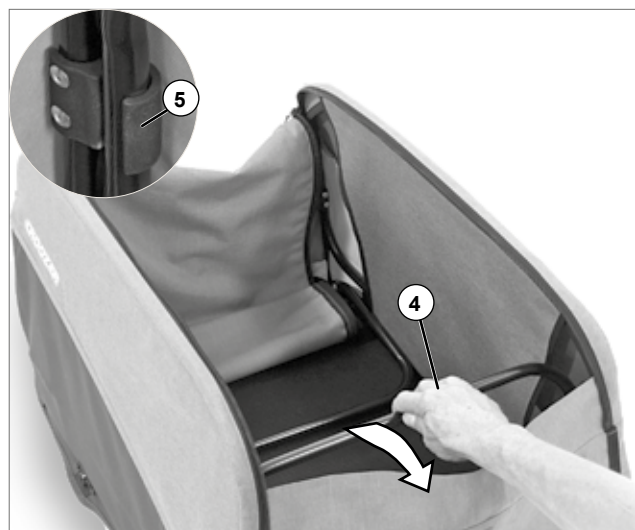

CAUTION!

RISK OF PINCHING OR CRUSHING! There are pinch points between the frame tubes that may cause painful injuries. Use caution to avoid these points when folding or unfolding the trailer.

Tip: A new Croozer Cargo will be slightly more difficult to unfold because the canvas is still stiff.

5. Check that the front and rear frame tubes (2 and 4) are snapped fully into all four clips (3 and 5) by pulling gently inwards on the two frame tubes. There should be no movement in the frame sections when you try to push them together.

NOTICE

If the locking mechanisms are not properly engaged, the frame of the Croozer Cargo could collapse while riding.

6. To fold the Croozer, follow these instructions in the reverse order. Open the cover all the way, and pull the frame tubes out of all four clips (3 and 5 on both sides).

Initial Assembly and Unfolding the Croozer Cargo

Attaching the cover

The cover is removable and can be attached by means of the two open-ended two-way zippers on the back section of the trailer.

This fastening system enables you to attach the cover on both sides and close it either fully or partially. If necessary, you can even remove the cover completely.



Attaching and removing the wheels

The wheels of the Croozer Cargo are equipped with push-button axles. By pressing the dust cap (1) on the wheel hub, the retaining balls (2) will retract within the axle to permit the attachment or removal of the wheel. The wheels cannot be attached or removed unless the dust cap is pressed in.

1. Remove the cardboard discs from the wheel axles. Save the discs for use when transporting the Croozer Cargo.
2. Use one hand to lift up the back of the Croozer Cargo.
3. Press the dust cap (1) of the wheel hub.
4. Insert the wheel axle (4) into the axle receiver (5) of the Croozer Cargo as far as it will go, and release the dust cap.
5. Check whether the wheel is locked securely in the axle receiver by pulling firmly on the wheel without pressing the dust cap. It should not be possible to remove the wheel without pressing on the dust cap.
6. Repeat steps 2-5 to attach the second wheel.

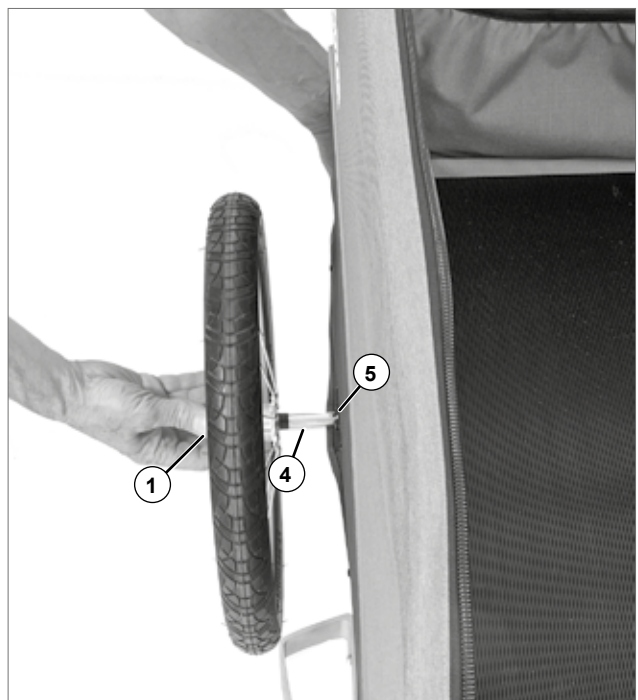
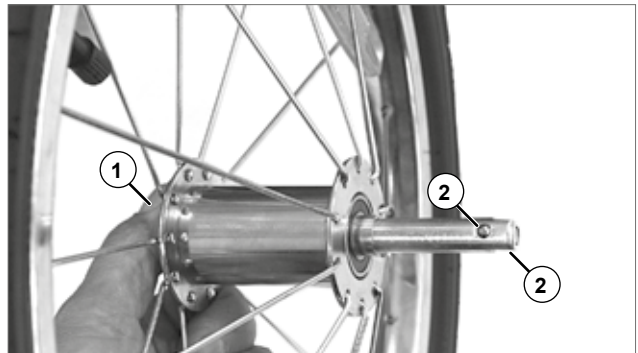

WARNING!

After the wheels have been attached, be sure to check that they are both locked securely in the axle receivers. This can be done by pulling on the wheels without pressing on the dust caps. After you have attached the wheels, it is vitally important that you check whether the axles are securely locked into the axle receivers by firmly pulling on the wheels. Wheels that are not securely locked in the axle receivers could fall off while riding, resulting in accidents with serious injury or death.

7. To remove the wheels, follow these instructions in the reverse order. Press the dust caps (1) and pull the wheel axles out of the receivers.

Preparing the Croozer Cargo for Use as a Bicycle Trailer

Installing and removing the hitch arm

The hitch arm is installed on the front left side of the Croozer Cargo (relative to the direction of travel). The Croozer Cargo is hitched to the left side of the towing bicycle (relative to the direction of travel).

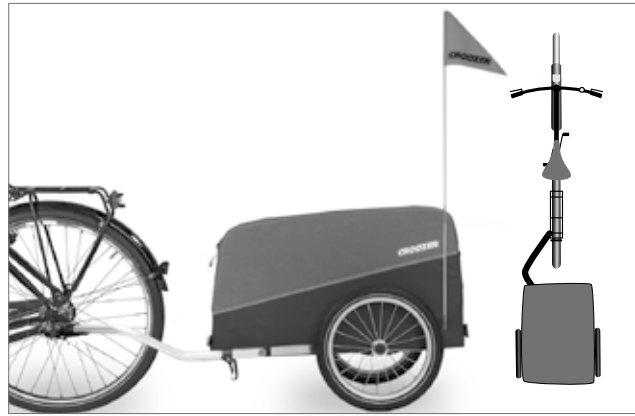

1. Raise the front of the Croozer Cargo slightly.
2. If the security pin (1) is inserted in the hitch-arm attachment bracket, pull out the security pin.
3. Hold the hitch arm (2) at an approx. 45° angle to the attachment bracket (3) and slide the end of the hitch arm (4) over the pin (5) attached to the frame of the Croozer.

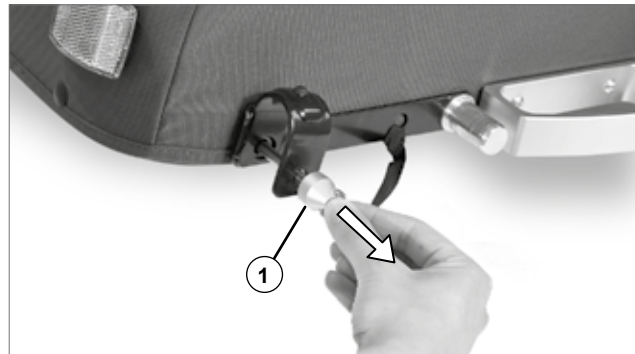

NOTICE

Do not let the strap of the security pin get caught between the hitch arm and attachment bracket as this could damage the strap.

4. Pull the front of the hitch arm upwards into the hitch-arm attachment bracket (3), and insert the security pin (1) as far as it will go through both holes of the hitch-arm attachment bracket. The head of the security pin is magnetic and will adhere to the hitch-arm attachment bracket.

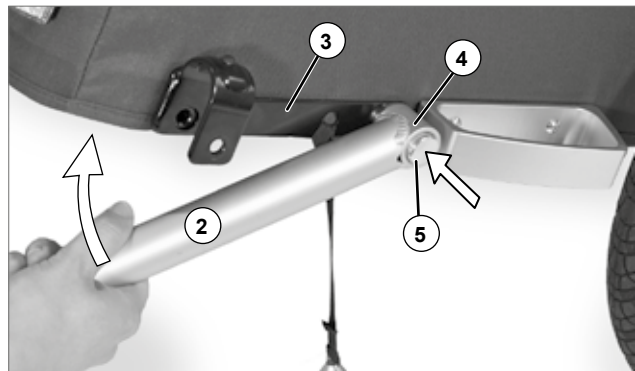

WARNING!

Always check that the security pin has been inserted as far as it will go through both holes and that it cannot fall out. If the security pin is not properly inserted, the hitch arm could fall off while in use, resulting in accidents with serious injury or death.

5. To remove the hitch arm, follow these steps in the reverse order.

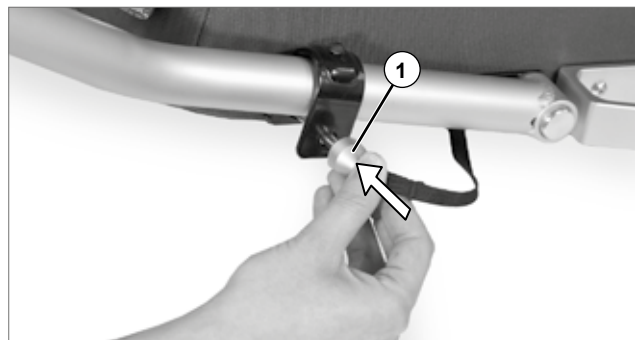

NOTICE

After removing the hitch arm, always lock the security pin back into the holes in the bracket. Never leave the security pin dangling from its strap. It could get caught on passing objects and be pulled off, damaging parts of the vehicle.

Never allow the magnetic security pin to come in contact with the ground. Otherwise, it could attract and accumulate magnetic debris.

Preparing the Croozer Cargo for Use as a Bicycle Trailer

Installing the axle hitch to the towing bicycle

The hitch is always mounted to the left side of the bicycle (relative to the direction of travel) and consists of two parts: a hitch connector (1), which is mounted to the hitch arm of the Cargo Trailer, and an axle hitch (2), which must be mounted to the rear axle of the towing bicycle.

Before installing the axle hitch, you must first check whether the bicycle is approved for towing a trailer. This information can be obtained from the bicycle manufacturer, a bicycle shop or the owner's manual of the bicycle.



WARNING!

It is vitally important to confirm that the towing bicycle is approved for pulling trailers. Pulling a trailer with a bicycle that has not been approved by its manufacturer for use as a towing bicycle can result in frame breakage or other material damage. Breakages of this kind could cause accidents with serious injury or death.

If you are not completely confident about your ability to install the axle hitch correctly, please consult with, or have the installation performed by, a professional bicycle mechanic.



WARNING!

It is vitally important that the axle hitch be properly installed. An improperly installed axle hitch could come loose while riding and cause accidents with serious injury or death.

Installing the axle hitch to a bicycle with a quick-release axle

The quick-release lever (1) must be positioned on the right side of the bicycle (relative to the direction of travel). If the lever is on the left side, the quick-release skewer must be removed and reinserted from the right side. Be sure to follow the applicable instructions in the owner's manual of the bicycle and/or consult a professional bicycle mechanic.

Tip: *If the bicycle wheel is equipped with a thru axle (with quick-release lever) instead of a conventional quick-release skewer, the thru axle must be replaced with the Croozer Thru Axle available as an accessory. Other hitch axles are also available as accessories.*

1. Open the quick-release lever (1) on the rear wheel of the towing bicycle or loosen the Allen bolt (5 mm), depending on the type of quick-release skewer. Often, the open position is indicated on the lever by the word "OPEN". In this case, when the word "OPEN" can be seen, the lever is in the open position.
2. Remove the axle nut (2) of the quick-release skewer by turning the nut anticlockwise. Use caution: The spring located just beneath the nut is under tension and could fly off when removing the nut.
3. Fit the axle hitch (3) over the end of the quick-release skewer by sliding the skewer (with the spring) through the hole in the hitch.

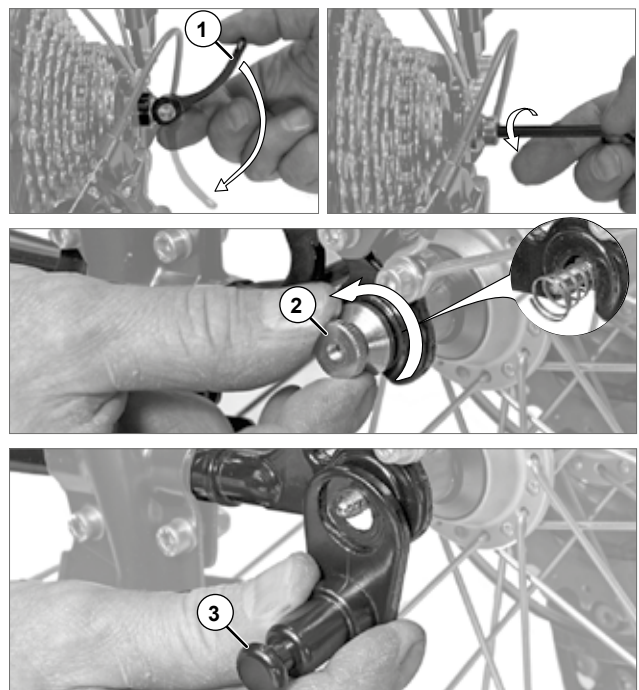
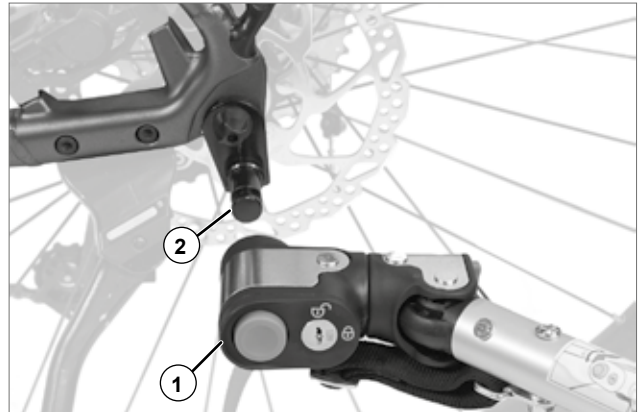

- Thread the axle nut (2) back onto the skewer. Tighten the axle nut at least five full turns (clockwise).



WARNING!

The axle nut must engage the threads for at least five full turns in order to ensure adequate clamping force for holding the rear wheel securely. Failure to tighten the axle nut adequately may result in accidents with serious injury or death. If the quick-release skewer is too short, it must be replaced. Consult a professional bicycle mechanic for the appropriate parts and assistance.

- Check that the rear wheel is properly aligned, adjusting the position if necessary; then close the quick-release lever (1) or tighten the hex bolt, depending on the version. Often, the closed position is indicated on the lever by the word "CLOSE". In this case, when the lever side marked "CLOSE" can be seen, the lever is in the closed position. If the tension-adjusting nut has been tightened the proper amount, you will be able to feel the resistance increase when the lever is about halfway closed, i.e. parallel to the axle. The adjustment is correct if you can fully close the lever but with considerable force. In the closed position, the lever should be parallel to the frame, i.e. it should not stick out to the side.
- Check whether the quick-release skewer is securely engaged by trying to rotate the quick-release skewer without opening the lever.

If the quick-release skewer is loose enough to rotate, then the clamping force is inadequate. In this case, open the lever, and tighten the tension-adjusting nut half a turn clockwise. Repeat steps 5 and 6.

If it is impossible to push the quick-release lever into the closed position, then open the lever, and unscrew the tension-adjusting nut half a turn anticlockwise. Repeat steps 5 and 6. Keep in mind that the tension-adjusting nut must engage the threads of the quick-release skewer for at least five full turns.

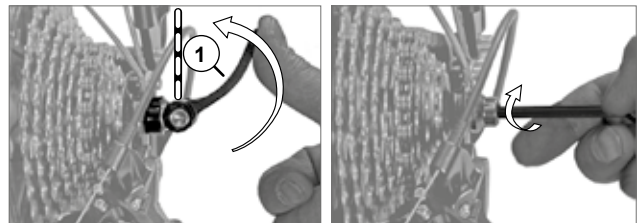
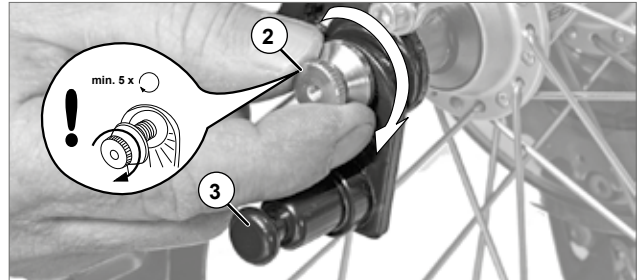

WARNING!

The tension-adjusting nut must engage the threads for at least five full turns in order to ensure adequate clamping force for holding the rear wheel securely. Failure to tighten the tension-adjusting nut adequately may result in accidents with serious injury or death. If the quick-release skewer is too short, it must be replaced. Consult a professional bicycle mechanic for the appropriate parts and assistance.

- Tip:** If there is not enough space for mounting the axle hitch or if the skewer threads are too short, then you can replace the original skewer with a Croozer Click & Crooz® Quick Release Skewer with integrated hitch, which is available as an accessory.

- Finally, hold the rear wheel with both hands and try to rock it back and forth to check that the wheel is held securely in the dropouts.



WARNING!

The rear wheel of the towing bicycle must be properly attached after the axle hitch has been installed. Riding with an improperly installed rear wheel can result in accidents with serious injury or death. Follow the instructions given in the owner's manual of the towing bicycle.



Preparing the Croozer Cargo for Use as a Bicycle Trailer

Installing the axle hitch to a bicycle with a solid axle

1. Remove the axle nut (1) on the left side of the solid axle by turning it anticlockwise.



WARNING!

It is vitally important that you leave the retaining washer (2) on the axle. This washer prevents the axle from rotating in the dropouts. Riding without the retaining washer can result in accidents with serious injury or death.

2. Without removing the retaining washer, place the axle hitch (3) onto the axle by feeding the end of the axle through the hole in the hitch.

3. Screw the axle nut (1) back onto the solid axle, tightening at least five full turns.



WARNING!

The axle nut must engage the threads for at least five full turns in order to ensure adequate clamping force for holding the rear wheel securely. Failure to tighten the nut adequately may result in accidents with serious injury or death. If it is not possible to tighten the nut at least 5 full turns, then the axle is too short, and the Universal Hitch cannot be used! Consult a professional bicycle mechanic for the appropriate parts and assistance.

4. Check that the rear wheel of the towing bicycle is properly centred, adjusting the position if necessary; then tighten the axle nut using the tightening torque specified in the owner's manual of the towing bicycle. Be sure to hold the axle hitch (3) in place while tightening the nut.
5. Finally, hold the rear wheel with both hands and try to rock it back and forth to check that the wheel is held securely in the dropouts.



WARNING!

The rear wheel of the towing bicycle must be properly installed after the axle hitch has been mounted. Riding with an improperly installed rear wheel can result in accidents with serious injury or death. Be sure to follow the instructions given in the owner's manual of the towing bicycle. When in doubt, consult a professional bicycle mechanic.

Tip: *If there is not enough space for mounting the axle hitch or if the threads of the axle are too short, then you can replace the original axle nut with a Croozer Click & Crooz® Axle Nut Hitch, which is available as an accessory.*

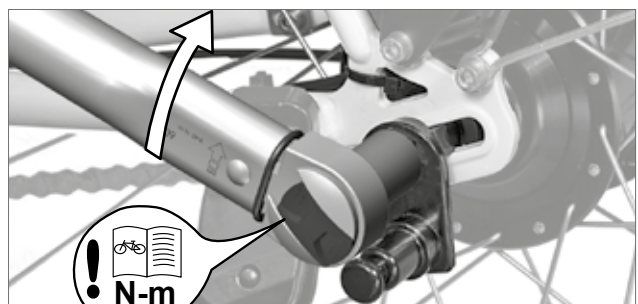
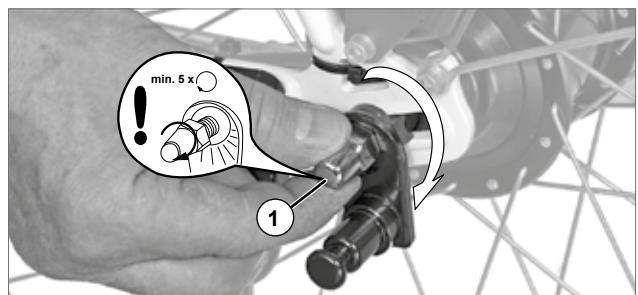
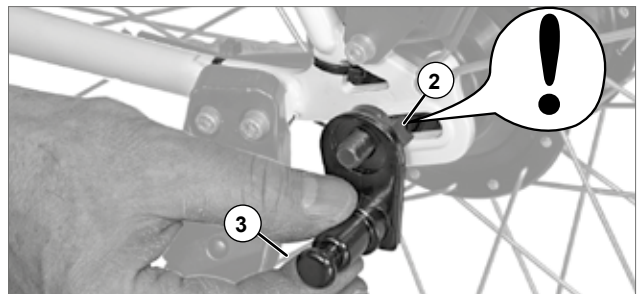
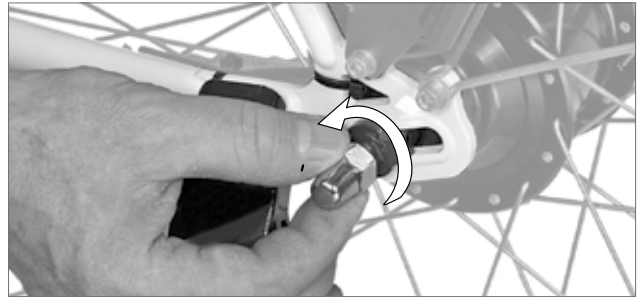
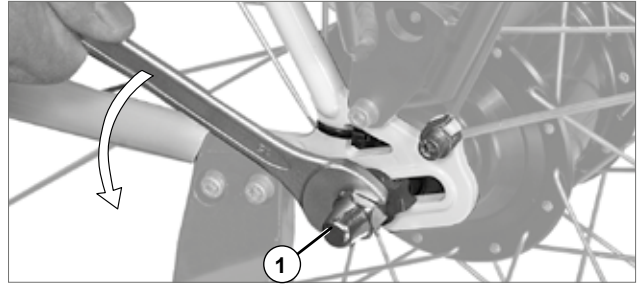

Accessory



croozer.com



Installing the safety flag

Never pull the Croozer Cargo as a trailer without the safety flag in place. The safety flag, which comes with your Croozer, makes it easier for other road users to see the trailer, increasing your safety and the safety of other road-users.

For the attachment of the safety flag, there is a loop (2) and a canvas sleeve (3) on the left side of the Croozer.

1. Assemble the flag pole (1) by connecting the two sections of the pole.
2. Slide the flag pole through the loop (2) and into the canvas sleeve (3).



WARNING!

When pulling the Croozer Cargo as a Cargo Trailer, the safety flag must be properly installed at all times. If the safety flag is not properly installed, other road users may fail to see the Croozer Cargo, which could result in accidents with serious injury or death.

NOTICE

The flag pole must always be inserted through both the loop (2) and the canvas sleeve (3). Otherwise, the flag pole could fall off while riding.



Using Your Croozer Cargo

Using Your Croozer Cargo

Transporting cargo

Load capacity and cargo compartment

The cargo area (1) of the Croozer Cargo offers enough space for larger cargo items.

Distribute the load evenly, and make sure that heavy items are centred over the axles of the side wheels (2). An unbalanced load has a negative effect on the handling of the trailer.



WARNING!

Be sure to properly secure all cargo items inside the Croozer Cargo. Cargo items can shift during transport, resulting in sudden changes in weight distribution. Never transport objects that are too large to fit completely into the cargo area of the trailer. Never attach cargo, such as bags or panniers, to the outside of the trailer. Shifting weight can cause erratic handling, which can lead to accidents with serious injury or death.

When using the Croozer Cargo, never exceed the weight limits specified below:

Maximum Load* (Cargo)	45 kg (99 lb)
------------------------------	---------------

* Weight limits only apply if the hitch-arm load is within the specified range of 3 to 11 kg (6.6 to 24.3 lb). See below.



WARNING!

Never overload the trailer and never ride with a hitch-arm load that is outside the specified range of 3 to 11 kg (6.6 to 24.3 lb). Always ensure that the load is evenly distributed. Failure to do so could compromise the handling properties and cause accidents with serious injury or death.

Proper weight distribution and hitch-arm load

For safe handling, the weight on the hitch connector should be between 3 and 11 kg (6.6 and 24.3 lb); the hitch-arm load (nose weight) is associated with an even distribution of weight in the trailer.

If the centre of gravity is too far forward, the hitch connector will be overloaded. If the centre of gravity is too far behind the wheels, the rear wheel of the towing bicycle could lose contact with the road, especially when making turns. If the centre of gravity is too far right or left, the trailer will have a greater tendency to tip over when making turns. Check the weight on the hitch connector before using the Croozer Cargo as a bicycle trailer.

Follow these steps, using your bathroom scales, to determine the weight on the hitch connector:

1. Place your bathroom scales beside the hitch arm of the loaded and unhitched trailer.
2. Step onto the scales and make a note of your weight.
3. Now, while standing on the scales, lift the hitch connector of the hitch arm about 30 cm (1 foot) off the ground.
4. The weight shown on the scales should be 3 to 11 kg (6.6 to 24.3 lb) more than your own weight.

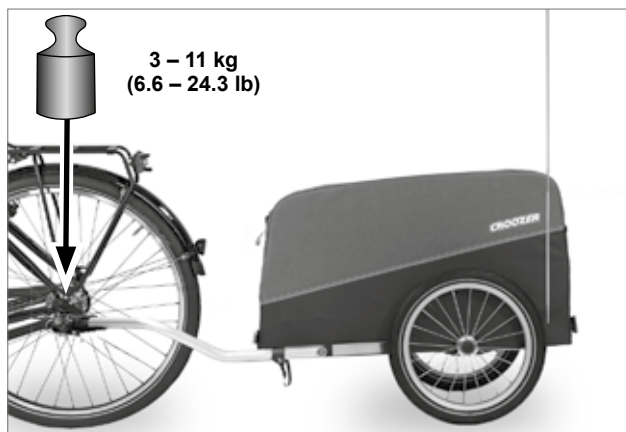
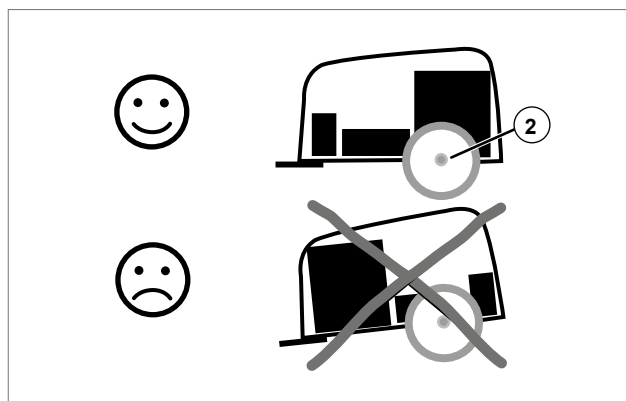

Opening, closing and removing the cover

The cover not only protects the cargo items inside the Croozer Cargo from dust, light rain or inquisitive eyes, but also prevents cargo from falling out of the trailer.

The cover is removable and can be attached by means of the two open-ended two-way zippers on the back section of the trailer.

It can be fully or partially opened and closed on both sides or completely removed.

1. Open the two zippers (1).
2. Remove the cover (2) completely or insert it into the pocket (3) at the rear of the trailer so that it does not get in the way when loading the trailer and so that it is not damaged when riding with an open cover.

NOTICE

Always insert the cover (2) into the pocket (3) when riding with an open cover. Otherwise, the cover could come in contact with the road or the wheels, causing damage to the cover.

3. To close the cover, follow these instructions in the reverse order.

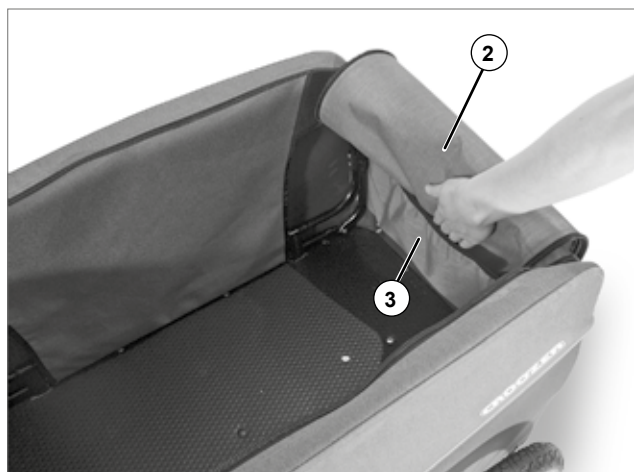
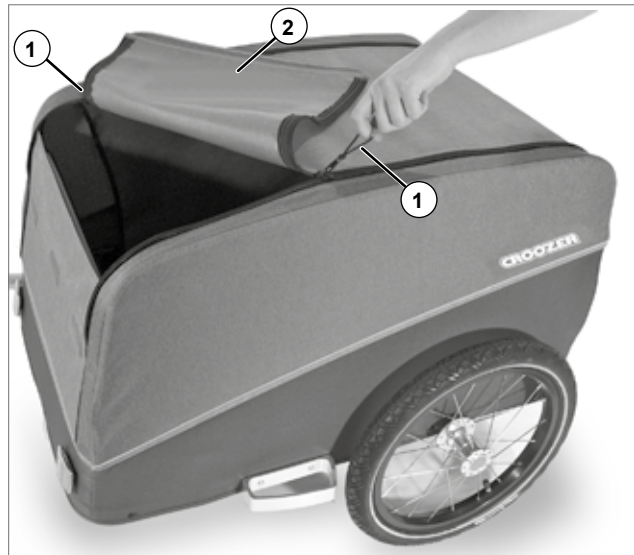

Using Your Croozer Cargo

Hitching the Croozer to the towing bicycle



WARNING!

It is vitally important that you check whether the towing bicycle has been approved by its manufacturer for pulling a trailer. Towing a trailer with an unsuitable bicycle can result in frame breakage and accidents with serious injury or death.

1. Lift the hitch arm of the Croozer, and push the hitch connector (1) as far as it will go onto the axle hitch (2) that has been installed on the towing bicycle. You should hear a click and be able to see that the axle hitch is securely engaged in the hitch connector. Pull gently on the hitch connector to ensure that it is locked securely to the axle hitch.

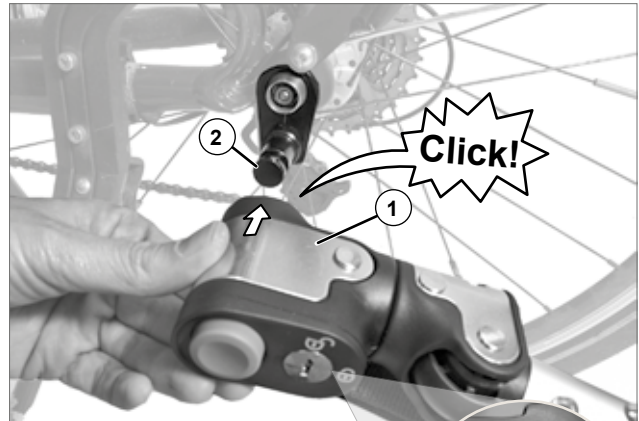

WARNING!

Always check to make sure that the axle hitch is locked securely in the hitch connector. If the axle hitch is not locked securely in the hitch connector, the Croozer could become unhitched while riding, resulting in accidents with serious injury or death.

2. Wrap the hitch-arm safety strap (3) around the seat stay of your bicycle, and push the pin (4) into the hole (5) until you hear it click into place. Pull up on the pin to make sure that it is locked securely in the hole.

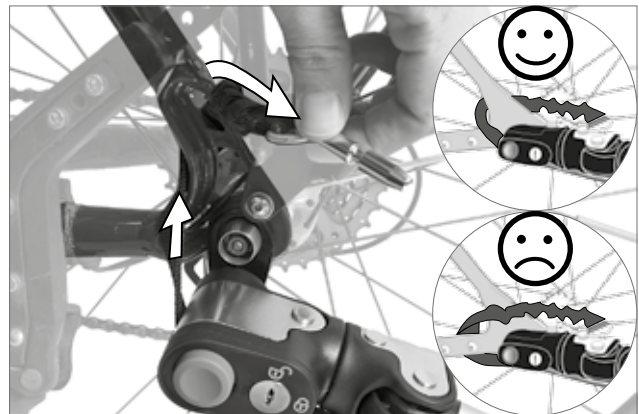

NOTICE

The front part of the hitch-arm safety strap is elastic. After the hitch-arm safety strap has been wrapped around the seat stay and the pin has been inserted into the hole, the strap should be under slight tension so that it cannot come in contact with moving parts. If the hitch-arm safety strap is not wrapped around the seat stay correctly, it could be destroyed by rotating parts like the spokes, hub or disc brake while riding.

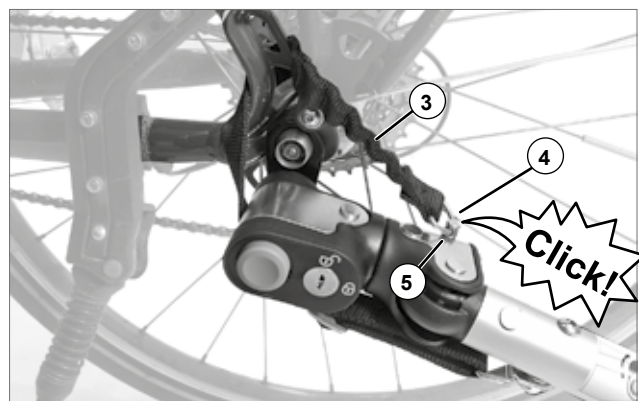

Tip: The length of the hitch-arm safety strap can be adjusted. The hitch-arm safety strap must be adjusted to the shortest possible length so that it cannot come in contact with the spokes, hub or disc brakes. Check, and if necessary readjust, the length of the hitch-arm safety strap whenever you attach the hitch arm to a different bicycle.





WARNING!

Never pull the Croozer as a trailer if the hitch-arm safety strap is defective or if the hitch-arm safety strap is not securely fastened to the towing bicycle. The safety strap ensures that the Croozer would remain connected to the towing bicycle if the hitch connector were to fall off the axle hitch. Failure to keep the safety strap mounted can result in serious injury or death.

- In order to prevent theft or the unhitching of the Croozer from the towing bicycle by an unauthorised person, the hitch connector is equipped with a hitch lock. This mechanism makes it possible to lock the Croozer to the towing bicycle.

Locking: Insert the key into the lock, turn the key to the horizontal position, and remove it.

Unlocking: Insert the key into the lock, turn the key to the vertical position, and remove it.



unlocked



locked

NOTICE

Never leave the key in the lock when riding with the trailer. The key could break off.

Tip: The hitch lock comes with three keys. If you need additional keys, you can have duplicates made by a locksmith or another key-cutting service (key blank Silca no. LS11).

Tip: If the lock becomes stiff after a while, you can lubricate the cylinder. However, it is important that you only use penetrating oil or a special spray for cleaning and lubricating locks. Conventional chain oil or grease will collect dirt and “gum up” the lock cylinder.

NOTICE

The hitch lock by itself does not adequately protect the Croozer from theft over longer periods of time. Always use one or more bicycle locks to secure both the towing bicycle and the Croozer to fixed, immovable objects, like lamp posts etc.

Tip: You can use a shackle lock or a cable lock to secure the side guards to an immovable object.



Unhitching the Croozer from the towing bicycle

- To unhitch the Croozer, follow the instructions above in the reverse order. Unlock the hitch connector and unfasten the hitch-arm safety strap. Press the button and pull the hitch connector off of the axle hitch.

Using Your Croozer Cargo

Special considerations when riding with the bicycle trailer

Speed

When pulling the trailer, never ride faster than its maximum allowable speed of 25 km/h (15 mph). Always reduce your speed to a walking pace when turning. Keep in mind that riding speed is often underestimated, especially on bikes with electric assist, which require less muscle power.



WARNING!

Riding too fast could cause the Croozer to skid or even tip over, resulting in accidents with serious injury or death.

Load capacity

Never transport more than the specified load capacity. Furthermore, never ride with less than 3 kg (6.6 lb) or more than 11 kg (24.3 lb) of weight on the hitch connector (nose weight). See section "Proper weight distribution and hitch-arm load" on page 16.



WARNING!

NEVER OVERLOAD THE CROOZER. Doing so can severely affect the Croozer's handling and cause accidents with serious injury or death.

Riding in conditions of poor visibility

If you plan to use the Croozer Cargo as a bicycle trailer at night, dusk or dawn – or when visibility is in any way reduced – it must be equipped with a lighting system. Battery-powered LED lights, for example, are commonly used lighting options. There are two mounting loops sewn onto the rear cover, near the top, for the attachment of a tail light. The tail light should be attached to the mounting loop on the left side (1) in countries with right-hand traffic and on the right side (2) in countries with left-hand traffic.



WARNING!

Never pull the Croozer as a trailer without lighting at night, dusk or dawn – or whenever visibility is in any way reduced. Other road users may not be able to see you, which could result in accidents with serious injury or death.



Special features of the Croozer Cargo Tuure suspension system

For extra comfort and additional safety when carrying heavy loads, the Croozer Cargo Tuure is equipped with an AirPad® suspension system with Sylomer® (3).

The innovative Croozer AirPad® suspension automatically adapts to the weight of the cargo. This means that, unlike suspension systems that require adjustment, the AirPad® system is never too stiff or too soft. Bumps are effectively absorbed to prevent the bicycle trailer from rocking. The system is maintenance-free and works equally well in cold and hot weather.

Tip: *The colour of the Sylomer® AirPads® may change slightly over time if exposed to sunlight. However, this colour change has no effect whatsoever on the function of the suspension system.*

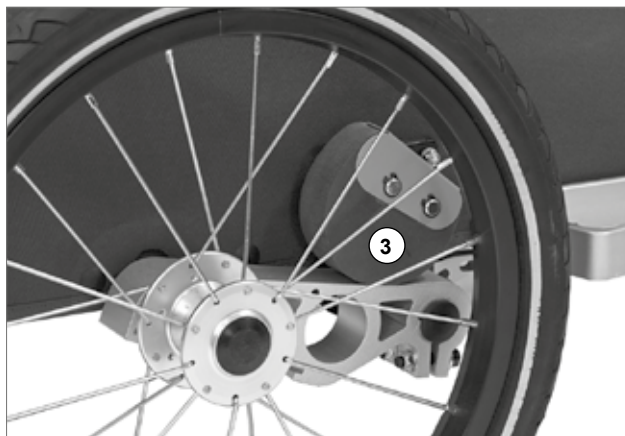

Tips for the towing bicycle

- For pulling the Croozer as a trailer, we recommend using a bicycle with multiple gears. The more speeds the bicycle has, the easier it will be to find the appropriate gear, for example, when starting, climbing hills or riding with a headwind.
- The towing bicycle must have two strong, independently operated brakes that are not only in perfect working order but also work effectively in wet weather conditions. This is absolutely essential, as the brakes must be able to stop the bike with the additional weight of the trailer.
- The towing bicycle must have a sturdy, rear-mount kickstand able to hold the bicycle firmly upright to guarantee safety and comfort when loading and unloading cargo. Single-legged kickstands mounted in the middle of the bicycle, under the bottom bracket, are NOT suitable because the weight of the hitched bicycle trailer, which rests on the rear axle, would make the parked bicycle unstable. Consult a bicycle shop for assistance in choosing the right kickstand.
- We recommend riding with a rear-view mirror on the towing bicycle. A rear-view mirror makes it easier to keep an eye on the vehicles behind you so that you can react appropriately. Always ride defensively.
- The towing bicycle should have a long rear mudguard with a mud flap to protect the trailer from dirt thrown up by the rear wheel of the towing bicycle.

Tips for riding with the trailer

- When pulling a loaded trailer, the handling, balance and performance of the towing bicycle will be affected, especially when starting, braking, turning or riding downhill. Prior to your first trip, we recommend taking a practice ride without cargo in a calm, traffic-free area. This is a great way to become acquainted with the handling of the bicycle and the dimensions of the trailer.
- The safety flag on the long, vertical pole will make you more visible to other road-users. Never ride without the safety flag properly mounted.
- Cyclists should always use available bike paths or lanes, even when pulling a trailer. Be especially careful when riding on narrow bike paths or lanes, as well as on paths and trails with two-way traffic. The trailer is generally wider than the handlebars of the towing bicycle. In addition, most trailers will not be centred behind the towing bicycle. Reduce your speed in places where navigation is especially challenging; and if you are ever in doubt about whether the trailer will be able to fit through an opening, dismount and push the bike and trailer through.
- Reduce your speed when riding on paths or streets with bumps or uneven surfaces. Reduce your speed when turning. Otherwise the centrifugal force could cause the trailer to tip over.
- Keep in mind that braking distance is increased when pulling a bicycle trailer.
- When turning left, never allow the angle between the rear wheel of the towing bicycle and the hitch arm of the trailer to be extended more than 90°. Turning at sharper angles could damage the hitch connector (1). Be extremely cautious when turning right, as sharp right turns can cause the rear wheel of the towing bicycle to hit the hitch arm, potentially damaging the hitch arm and/or the rear wheel of the towing bicycle (2).

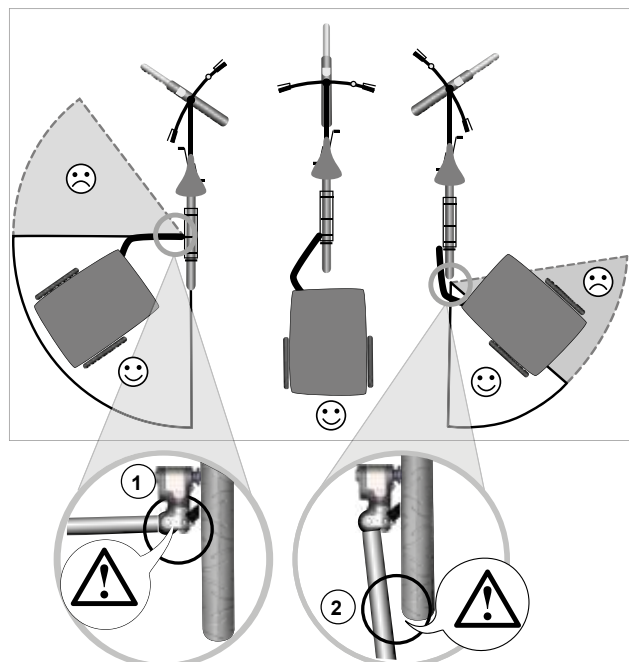

Using Your Croozer Cargo

- When pushing the towing bicycle backwards, keep in mind that the angle between the rear wheel of the towing bicycle and the hitch arm of the trailer must never be greater than 90° . The hitch connector could be damaged if bent beyond this angle. When manoeuvring backwards, it is advisable to lift up the rear wheel (3) of the towing bicycle or, ideally, the whole bicycle.
- If you are planning a cycling trip with the bicycle trailer in another country, be sure to familiarise yourself in advance with the legal requirements that apply in the regions or countries you intend to visit. Some countries do not permit the use of bicycle trailers, and others impose certain age restrictions for their use.
- The equipment legally required for bicycle trailers varies from country to country, and sometimes even from state to state. Be sure to observe and comply with the laws that apply in the country or state in which you will be using the Croozer Cargo.



Transporting Your Croozer Cargo

The Croozer Cargo can be folded to a compact size for transport.

1. Before folding, remove all non-component items from the Croozer Cargo.
2. Remove the hitch arm and safety flag.
3. Remove the side wheels. See page 10.
4. Place the cardboard discs from the original Croozer packaging materials over the wheel axles. Then insert the wheel axles into the holes in the floor of the trailer. (For the models Pakko and Tuure, both wheels are secured inside the trailer, and for the model Kalle, one wheel is secured inside the trailer and the second is attached under the floor of the trailer.) This saves space and prevents the wheels from sliding around inside the Croozer Cargo during transport. Place all other removed parts inside the cargo compartment. Use packaging material for padding if desired.
5. Push the fabric (1) from the top frame tubes to the outside in order to reduce the tension in the side panels when folded. Place the cover inside the trailer and fold down the sides of the Croozer Cargo. See instructions on page 9.
6. The Croozer Cargo is now ready for transport in a vehicle.

NOTICE

Check that no sharp objects are positioned in such a way that they could damage the fabric body during transport. Use padding material.

NOTICE

Never transport the Croozer Cargo – even when folded – on the roof of a motor vehicle, as this could damage the fabric body.

Tip: Use caution when placing the folded Croozer into the trunk of a car or laying it on the floor of a room, because the exposed metal parts beneath the Croozer could damage the surface it is placed on.

7. For air travel etc., we recommend packing the folded Croozer Cargo in its original box. Use padding material to prevent the Croozer from moving around inside the box.

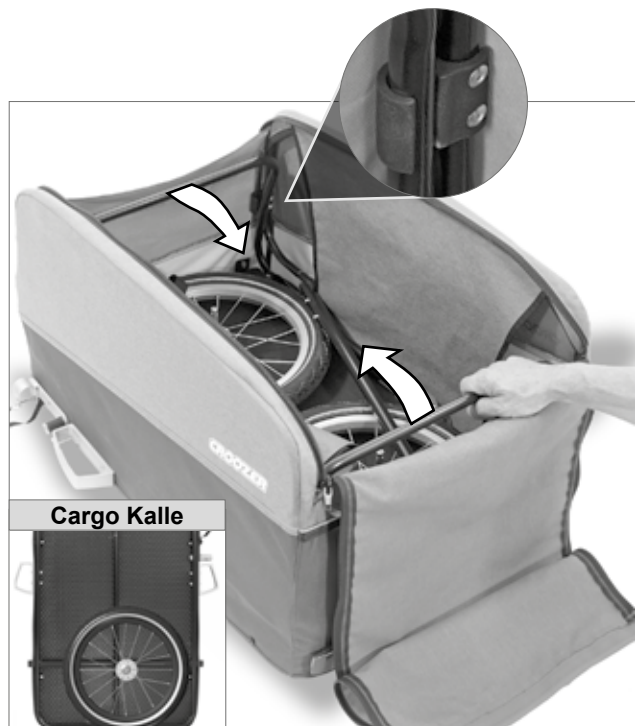
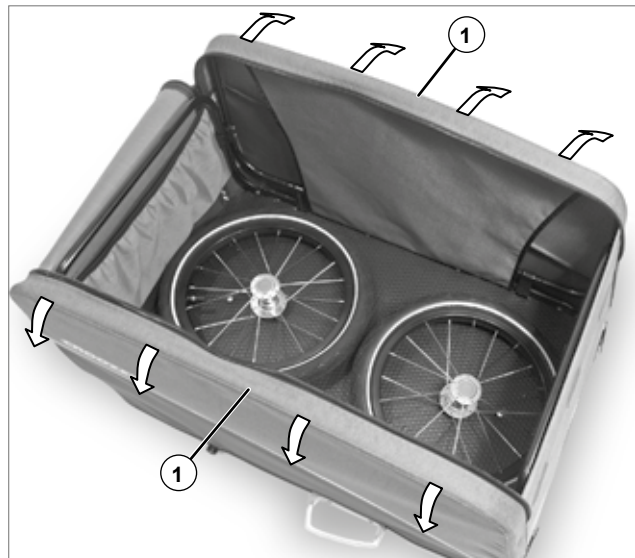

Croozer Cargo Inspections and Maintenance

To ensure that your Croozer Cargo will have a safe, long and problem-free service life, inspections and maintenance must be performed at regular intervals. The Croozer Cargo's wheels, hitch arm, frame, fabric body, security pins, hitch connector and hitch must be checked periodically for damage. If any of these parts are found to be damaged, the Croozer Cargo may not be used until the damage has been properly repaired.



WARNING!

Never use the Croozer Cargo if it is not in perfect working order. Damaged parts could cause accidents with serious injury or death. Therefore, be sure to have your Croozer Cargo serviced regularly – at least once a year – by a professional bicycle mechanic.



WARNING!

It is vitally important that the maintenance work described in this section be performed to professional standards and at the specified intervals.

Inspection intervals

Check the overall condition of the Croozer Cargo before each use, or daily, to identify any parts in need of repair or replacement. Generally, a visual inspection is sufficient: Is everything where it belongs, are there any tears in the fabric body, are any of the metal parts cracked or bent, are the tyres in good condition and properly inflated, are all security pins securely locked in the appropriate positions and, if applicable, are the accessories in perfect working order? A complete checklist for inspection is provided in the table on the right.

Service intervals

Be sure to have your Croozer Cargo serviced regularly – at least once a year – by a professional bicycle mechanic. The required frequency of maintenance will depend on various factors, such as weather conditions, road conditions, loading etc. If the Croozer Cargo is not being used very often, then an annual service by a professional bicycle mechanic is sufficient. If the Croozer Cargo is used on a daily basis, even in the winter, then we recommend having it professionally serviced more often, as the parts can wear significantly faster. Using a bike with electric assist to pull the trailer can also subject the parts to much greater wear, meaning that shorter service intervals may be necessary.

Before each use	What should be done?
Visual inspection by user	
Overall condition	Check for damaged parts
Fabric body	Check for tears etc.
Locking mechanisms and fastening systems	Check for proper function and whether securely locked
Hitch arm, hitch connector and axle hitch	Check for damage and proper installation
Attachment of side wheels	Check that the axles are locked securely in the axle receivers
Hitch connector and hitch-arm safety strap	Check for correct attachment
Light	Check for proper function
Tyres	Check tyre pressure, check for damage/cracks
Quick-release axles with retaining balls and push-button pins (side wheels)	Check for proper function
Cargo weight and hitch-arm load (nose weight)	Ensure that all values are within specified limits
Safety flag on trailer	Check that flag is installed
Towing bicycle	Check that towing bicycle is in perfect working order

Monthly*	What should be done?
Tyres	Check tyre pressure, check for damage/cracks, check tread depth
Side wheel axles	Clean and lubricate retaining balls and push-button pins

Yearly*	What should be done?
Full maintenance check	Vehicle must be serviced by a professional bicycle mechanic

* depending on type and frequency of use

Inspecting the hitch arm, hitch connector and hitch

Inspect the hitch arm, hitch connector, hitch and their respective attachment sites regularly for damage. If a part is cracked, dented, bent or damaged in any way, the Croozer Cargo may not be used with the respective part until it has been replaced or repaired. Have all damaged parts repaired or replaced immediately by a professional bicycle mechanic. Check that the axle hitch is securely fastened.

Inspect the fabric body

Check the fabric body and the cover regularly for damage. Small tears or holes can be repaired. In the case of irreparable damage, the fabric body should be replaced.

Inspecting and servicing the side wheels

The wheels should be checked for trueness on a regular basis and retued as necessary. An annual wheel inspection by a professional bicycle mechanic is usually sufficient.

Checking tyre pressure and treads

Check the tyre pressure before each use. The actual tyre pressure should never be higher or lower than the maximum and minimum inflation pressures marked on the tyre sidewall (1). Riding with under-inflated tyres can damage the tyres and rims. Over-inflation can cause the inner tube or tyre to explode. The inner tubes have Schrader valves, also known as car valves. You will need a pump with the appropriate nozzle. Never use compressed air, e.g. from a gas/petrol station, to fill your tyres. The rapid airflow and high pressure can over-inflate the tyres, causing the tube and/or tyre to burst.



WARNING!

Inspect the tyres periodically for adequate tread depth and any signs of damage or excessive wear. Worn-out or damaged tyres can affect the handling and even burst, which could result in accidents with serious injury or death.

Servicing the lock cylinder on the hitch connector

The lock cylinder may become stiff or difficult to turn after a while and should only be lubricated with penetrating oil or a special spray for cleaning and lubricating locks. Conventional chain oil or grease will collect dirt and “gum up” the lock cylinder. The lock cylinder should be serviced at least once a year, depending on weather exposure.



Cleaning and lubricating the wheel axles

The side wheels are equipped with a special mechanism for easy attachment and removal. The retaining balls (1) and push-button pins (2) of the axles must be cleaned and lubricated on a regular basis.

WARNING!

The retaining balls (1) and push-button pins (2) of the axles must be cleaned and lubricated on a regular basis. Otherwise, a wheel could fall off while riding, resulting in accidents with serious injury or death.

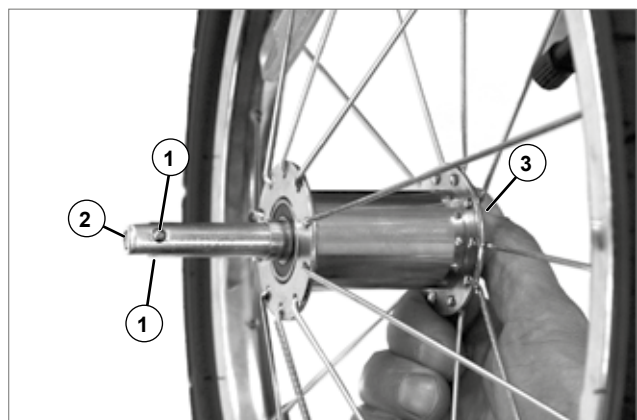

Cleaning, Maintaining and Storing the Croozer Cargo

1. Wipe off the axle with a clean cloth to remove dirt and grime.
2. If any dirt or grime remains around the push-button pin (2) or retaining balls (1), then clean them with a small brush or a clean cloth.
3. Lubricate these parts, and press the button (3) on the axle several times to distribute the lubricant evenly. The push-button pin and retaining balls must be able to move freely.
4. Use a clean cloth to wipe off any excess lubricant.

Tip: *The axle can be lubricated using a bicycle-chain lubricant.*

Inspecting the Croozer after an accident

If the Croozer Cargo has been involved in an accident, it must be inspected by a professional bicycle mechanic before it can be used again. Even if there is no visible damage. Accidents can leave behind tiny, and often invisible, hairline cracks in critical components whose failure would adversely affect the safety of the vehicle.

Cleaning, Maintaining and Storing the Croozer Cargo

How do I clean and maintain my Croozer Cargo?

Fabric body, frame and metal parts

Clean the fabric body and all metal parts with water, a soap solution or a mild household detergent. Use biodegradable cleaning agents whenever possible to minimise environmental impact. A soft brush can be used to clean areas of heavy soiling.

Never use solvents, such as mineral spirits, or other aggressive chemicals, as these can damage or destroy the fabric or the metal parts. Never use pressure washers. The strong water pressure could damage the fabric or force water into the wheel bearings, shortening their service life.

To protect metal parts from corrosion, a thin coat of paste wax can be applied. Preserving metal parts with paste wax is especially important if you plan to use the Croozer Cargo often in wet weather, in salty air near the sea or in the winter.

How do I store my Croozer Cargo?

General information

Store your Croozer Cargo, if possible, in a dry, warm and well-ventilated area. The minimum storage temperature is -4°F (-20°C); lower temperatures could cause the fabric to become brittle.

If you cannot store your Croozer Cargo indoors, then use a waterproof cover to protect it from the rain. The best way to protect the Croozer Cargo when not in use is with the Storage Cover available as an accessory (see page 31).

Avoid long-term exposure to direct sunlight, which will fade the fabric over time.

If possible, avoid using the Croozer Cargo in salty air, e.g. near the sea, or during winter months on salted roads, as the salt can corrode metal parts. To protect these parts from corrosion, apply a thin coating of paste wax to all metal surfaces.

Long-term storage

If you will not be using your Croozer Cargo for an extended period of time, for example over the winter months, then prepare the vehicle for storage as follows:

1. Clean the Croozer Cargo thoroughly as described above.
2. Allow the Croozer Cargo to dry completely, and apply paste wax to protect metal parts from corrosion.
3. Store the Croozer Cargo in a dry, dust-free and well-ventilated room. Cover the Croozer Cargo with an appropriate sheet or tarp/tarpaulin. The best way to protect the Croozer Cargo when not in use is with the Storage Cover available as an accessory (see page 31).

NOTICE

To prevent mildew and mould growth, the Croozer Cargo must be completely dry and clean before being put into storage.

Tip: *To save space, the Croozer Cargo can be stored in its folded state.*

4. Inner tubes will slowly lose pressure over time. Storing the Croozer Cargo on flat tyres for an extended period of time could damage the tyres. Therefore, if you plan to store the Croozer Cargo for several weeks or months, it should be either propped up with its wheels off the ground or hung from a wall or ceiling. You can also remove the wheels and store them on their sides. Otherwise, be sure to check the tyre pressure periodically, and keep the tyres inflated.
5. Before using your Croozer Cargo after a long period of storage – for example, if you have stored it over the winter – check that it is in perfect working order, and have it serviced by a professional bicycle mechanic.

Preparing the Croozer Cargo for disposal

Croozer products are extremely durable and robust. However, if the Croozer Cargo must be disposed of, e.g., owing to severe damage etc., then contact your Croozer dealer, who can help you dispose of the Croozer, or individual parts, in an environmentally sound manner. Furthermore, be sure to dispose of any worn parts, such as tyres, in an environmentally sound manner. When in doubt, consult a Croozer dealer.

Tip: *The fabric of the Croozer Cargo body is not, in itself, an ideal medium for the growth of mould and mildew. Moulds feed off organic matter in the fabric, e.g. food residues, dirt etc., and grow best in warm, damp and humid conditions. Therefore, it is very important that you follow these storage guidelines to prevent mould growth.*

However, if you do happen to find mould or mildew on your Croozer Cargo, it can be cleaned in mild cases, using a mild alcohol-based cleaning agent, 5% household vinegar or a 5% sodium bicarbonate solution from the pharmacy. NEVER USE HARSH CHEMICAL FUNGICIDES. For severe cases of mould or mildew, the fabric body must be replaced. Contact a Croozer dealer for assistance.

Technical Data

Technical Data

Dimensions and Weight of Empty Chassis	See catalogue or croozer.com
Maximum Weight of Loaded Trailer (Trailer + Cargo)	60 kg (132 lb)
Maximum Load* (Cargo)	45 kg (99 lb)
Maximum Speed with Trailer Maximum Speed with Handcart (accessory)	25 km/h (15 mph) 7 km/h (4.3 mph)
Minimum Temperature for Use/Storage	-20°C (-4°F)
Wheel/Tyre Size	16", 47-305 (16 x 1.75 inch)
Recommended Tyre Pressure	Minimum and maximum values marked on tyre sidewall
Valves	Schrader (car valve)
Size of Handcart wheel (accessory Handcart Kit)	8"

* Weight limits only apply if the hitch-arm load is within the specified range of 3 to 11 kg (6.6 – 24.3 lb).
See page 16.

Tested for Safety

All Croozer Cargo models are regularly tested and inspected, not only in our own facilities, but also by independent institutes, newspapers/magazines and testing laboratories.

To ensure compliance with the relevant standards, Croozer Cargo trailers are subject to numerous tests, such as extensive stress testing on the frame, hitch arm and other parts. Furthermore, the functionality of all systems, e.g. the folding mechanism, is thoroughly tested.

Materials tested for harmful substances

All materials are tested for harmful substances to achieve standards over and above the legal requirements.

We guarantee that your Croozer is a completely safe product that satisfies all current testing criteria.

Additional information:

croozer.com/en/testing-and-compliance



EU Declaration of Conformity and Warranty

EU Declaration of Conformity

To enable the free movement of goods and services within the EU, there are a number of EU directives which set uniform, Europe-wide requirements for products:

e.g. the Machinery Directive, Pressure Equipment Directive, Toy Safety Directive and Medical Device Directive, just to name a few. Products that are subject to an EU directive must bear a CE marking to confirm that the product complies with the requirements imposed by the European Union. For some products, including bicycle trailers, there are no specific EU directives. As a result, these products have no CE marking and are not allowed to be labelled with one. However, these products are subject to the German Product Safety Act based on the European Directive 2001/95/EC.

Croozer GmbH confirms that the design and construction of all Croozer products placed on the market comply with the basic health and safety requirements laid down by the German Product Safety Act (ProdSG). The following harmonised standard has been applied:
DIN EN 15918:2011+A2:2017 Cycles - Cycle trailers - Safety requirements and test methods.



Warranty

In addition to the statutory warranty under the contract of sale, we, Croozer GmbH, extend to you, as the consumer, the following manufacturer's warranty for our bicycle trailers.

The customer's statutory rights are not impaired by this warranty. The warranty conditions are set forth below:

What does the warranty cover?

- For defects in the materials or workmanship of the safety frame of all of our bicycle trailers, we offer a warranty of 10 years beginning on the date of original purchase. The safety frame is shown in black in the illustration on the right.
- In addition, for defects in the materials or workmanship of the splash guard, fabric body, parking brake system, bumper, handlebar, wheels, hitch arm, hitch connector or hitch of our bicycle trailers manufactured in or after 2018, we offer a warranty of 3 years beginning on the date of original purchase.

Under what conditions is the warranty provided?

This manufacturer's warranty only applies to bicycle trailers that have been used in accordance with this owner's manual, particularly the safety information, and that have not undergone any structural changes, modifications, or improper repair work.

What doesn't the warranty cover?

- Damages caused by normal wear and tear or improper handling, such as the use of force, i.e. damages that were not caused by defects in materials and workmanship.
- Damages caused by incorrect assembly.

Dealers

- Cuts, scratches or other damages caused by an accident.
- Damages caused by improper storage, unauthorised modifications or the use of improper cleaning methods or agents.

NOTICE

Please read and observe the installation, assembly, usage, care and maintenance instructions provided in this owner's manual. Failure to observe these instructions could result in faulty operation, material damage and/or increased wear.

What happens in the case of a warranty claim?

Warranty claims must be accompanied by the original sales receipt with the date of purchase, as well as the bicycle trailer.

In the case of a warranty claim, Croozer will inspect the bicycle trailer and determine whether the claim is covered by the warranty.

If the trailer is deemed eligible for repair or replacement under the terms of this warranty, Croozer can, at its own discretion:

- repair the bicycle trailer using new parts or parts that are equivalent to new parts in terms of their utility and functionality,
- replace the bicycle trailer with a trailer of the same model or, with your approval, with a similar model (a trailer made from new and/or used and functional parts that are as good as new), or
- refund the purchase price in exchange for the return of the damaged bicycle trailer.

The replacement parts, replacement products or repaired bicycle trailers provided by us in the context of this manufacturer's warranty assume the remaining term of the warranty for the original bicycle trailer or receive a three-month warranty starting on the day of the replacement or repair, depending on which time period is more favourable to you.

How to reach us in the case of a warranty claim

If you notice any issues with your Croozer, contact the dealer from whom you purchased your Croozer. The dealer will either help you directly or forward your claim to us. In order to process your claim, we – and/or your dealer – will need the original sales receipt, the serial number of your bicycle trailer and, in the case of a warranty claim, the Croozer bicycle trailer. You can find the serial number beneath the trailer, on the inner surface of the base frame.

Dealers

A list of authorised dealers in your area can be found on the Croozer website: croozer.com.



Accessories

Several accessories are available for making the Croozer Cargo even more versatile and easy to use. All accessories can be purchased from a Croozer dealer or the Croozer online shop: croozer.com.

Handcart Kit

Comes with easily stowable, length-adjustable handle and a Handcart wheel that can be quickly and easily mounted, allows for effortless manoeuvrability in small spaces and can be stored inside the trailer in a convenient pouch (included).



Rain Cover

Waterproof fabric: polyester with PU coating is waterproof to a hydrostatic head of 5000 mm, eye-catching colour and reflective strips on all sides for improved visibility



Storage Cover

For protecting the parked trailer from weather and dust



Click & Crooz® Universal Hitch

For an additional towing bicycle



Click & Crooz® Axle Nut Hitch



Click & Crooz® Thru Axle Hitch

Available in various lengths and thread sizes



Quick-Release Skewer with integrated Click & Crooz®



More accessories can be found at



croozer.com

.....

CROOZER

Croozer GmbH
An der Hasenkaule 10
50354 Hürth, Germany
www.croozer.com

