

Croozer Kid for 1

Croozer Kid for 2

3-in-1 Buggy
Bicycle Trailer
Stroller

OWNER'S MANUAL
ENGLISH



CroozerKid-ENG-10-2012

Item Number: 124 000 313

CROOZER

www.croozer.eu

IMPRINT

Published by: Zwei plus zwei GmbH
Oskar-Jäger-Str. 125
D-50825 Cologne
Germany

Copyright © 2012 Zwei plus zwei GmbH. All rights reserved. No part of this manual may be reproduced or transmitted in any form for any purpose other than the purchaser's personal use.

Additional manuals and instructions on the use of this vehicle and its accessories can be ordered from Zwei plus zwei GmbH or downloaded from the website www.croozer.eu. Every effort has been made to ensure the accuracy of this manual. However, if you do find an error, we would appreciate hearing about it so that we can correct it.

Planning, text, graphic design and editing:
W. Piontek, www.technik-transparent.de

Photos: W. Piontek and Zwei plus zwei GmbH

Table of Contents

Description	2	Transporting your Croozer Kid	36
What's what?	2	Croozer Kid Inspections and Maintenance.	37
3-in-1 System	3	Inspection intervals	37
Quick-releases and Security Pins	3	Service intervals	37
What is the Croozer Kid?	4	Inspecting the hitch arm, hitch connector, Stroller Kit components and Buggy wheel	38
How should the Croozer Kid be used?	4	Inspect the fabric body	38
How shouldn't the Croozer Kid be used?	4	Inspecting and servicing the wheels	38
Orientation and wording	4	Checking tyre pressure and treads.	38
Applicable standards	4	Cleaning and lubricating the wheel axles	39
Safety Guidelines	5	Inspecting the Croozer Kid after an accident.	39
Symbols and warnings	5	Cleaning and Storing the Croozer Kid	40
Read and observe this manual	5	How do I clean and maintain my Croozer Kid?	40
Who can ride in the Croozer Kid?	5	How do I store my Croozer Kid?	40
Who can ride the towing bicycle?	5	Preparing the Croozer Kid for disposal.	41
Requirements for the towing bicycle	5	Technical Data	42
Legal requirements for transporting children.	6	Accessories	43
Before your first ride...	6	Warranty	44
Pulling the Croozer Kid as a Bicycle Trailer	6	Servicing and warranty claims	45
Using the Croozer Kid as a fixed-wheel Stroller	7	Distributors	45
Storage and transport	7		
Assembly, maintenance and repair	7		
Initial Assembly and Unfolding the Croozer Kid	8		
Checking package contents	8		
Unfolding the Croozer Kid	9		
Installing the bumper, reflectors and brake shoes	10		
Attaching and removing the wheels	12		
Attaching and removing the handlebar with safety wrist strap	13		
Converting the Croozer Kid to a Bicycle Trailer	14		
Installing and removing the hitch arm	14		
Installing the hitch nut to the towing bicycle	15		
Installing the safety flag	18		
Converting the Croozer Kid to a Buggy	19		
Installing the Buggy wheel	19		
Converting the Croozer Kid to a Stroller	20		
Attaching the wheel arms	20		
Installing the Stroller wheel.	21		
Using the safety wrist strap	22		
Using your Croozer Kid	23		
Engaging and disengaging the parking brake	23		
Opening and closing the cover.	24		
Loading and unloading passengers	24		
Fastening and unfastening the safety harness.	25		
Adjusting the safety harness	26		
Adjusting the head pads	26		
Transporting cargo	27		
Hitching the Croozer Kid to the Towing Bicycle	29		
Special considerations when riding with the Bicycle Trailer	30		
Special considerations when using the Buggy.	33		
Special considerations when using the Stroller	34		

Description

Description

What's what?



3-in-1 System

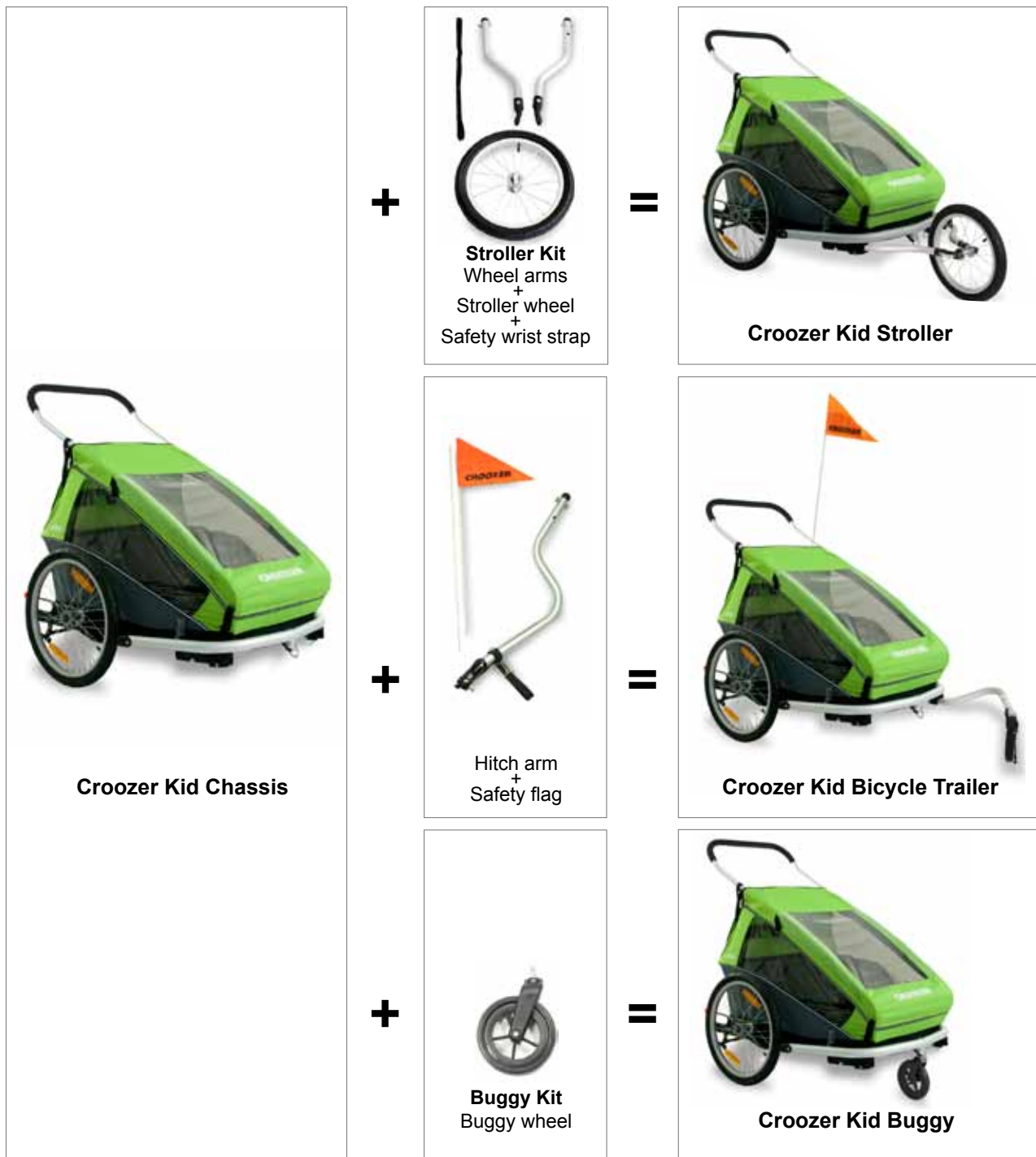

Quick-releases and Security Pins

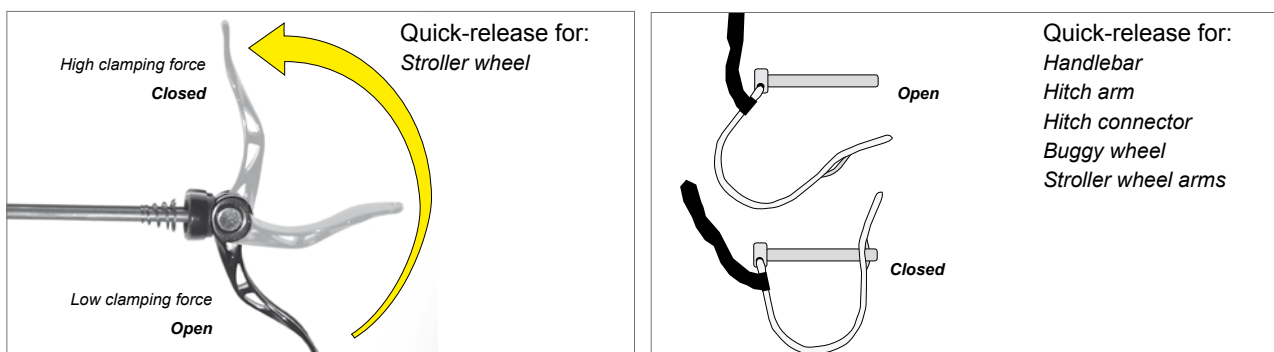

Description

What is the Croozer Kid?

The Croozer Kid is a vehicle for transporting children. It consists of a Chassis that can be quickly and easily converted to a Bicycle Trailer, a swivel-wheel Buggy or a fixed-wheel Stroller. No longer will you need a fleet of vehicles because, with the Croozer Kid, you can take your child on a bike ride, a walk in the park or a trek through the countryside. It can even be used as a fixed-wheel sport stroller for walking.

How should the Croozer Kid be used?

The Croozer Kid is intended for private use for carrying children in daylight hours on roads and other smooth, well-surfaced paths as a Bicycle Trailer, a swivel-wheel Buggy or a fixed-wheel Stroller. The instructions and safety guidelines provided in this manual must be followed at all times. Only children who are able to sit upright unassisted and are within the specified age range should ride in the Croozer Kid. Be sure to secure all cargo and take-along items in the designated pockets and compartments and observe the weight limits specified in the table below. It is vitally important that all cargo be secured to prevent it from shifting while the Croozer Kid is in use. It is the user's responsibility to ensure that the transported cargo does not compromise the safety of the passengers.

Maximum Weight of Loaded Trailer (Trailer + Passengers + Cargo)	
Croozer Kid for 1	100 lbs (45 kg), max. 1 child
Croozer Kid for 2	132 lbs (60 kg) max. 2 children
Maximum Weight of Passengers	
Croozer Kid for 1	33 lbs (15 kg), max. 1 child
Croozer Kid for 2	2 x 33 lbs (2 x 15 kg), max. 2 children
Load Capacity for Cargo Areas*	
Rear cargo compartment	max. 11 lbs (5 kg)
Handlebar Console (accessory)	max. 4.4 lbs (2 kg)
Minimum Age of Passengers	
Without Infant Sling	6 months (if child can sit upright unassisted)
With Infant Sling (accessory)	1 month
Maximum Age of Passengers	
Without Infant Sling	6 years
With Infant Sling (accessory)	10 months
Maximum Height of Passengers	
	46 inch (117 cm)
Hitch-arm Load (Nose Weight)	
	6.6 to 17.6 lbs (3 - 8 kg)

* Weight limits only apply if the hitch-arm load is within the specified range of 6.6 to 17.6 lbs (3-8 kg). See page 28.

When in use as a Bicycle Trailer in poor visibility conditions or at night, dusk, or dawn, the Croozer Kid must be equipped with a lighting system that complies with the applicable laws and regulations in the country of use. Any spare parts used for the Croozer Kid must be approved by Zwei plus zwei GmbH and properly installed, ideally by a professional bicycle mechanic. Use only accessories that are suited for the Croozer Kid and/or have been approved by Zwei plus zwei GmbH.

How shouldn't the Croozer Kid be used?

The Croozer Kid may not be used in any manner other than as specified above. Never transport animals together with children in the Croozer Kid. Never use the Croozer Kid as a cargo trailer. Never use the Stroller or Buggy for jogging or skating. Commercial use, overloading, excessive speeds, improper repairs and use on unsurfaced roads or paths are not permitted. Never install a car seat or other seating device not approved by Zwei plus zwei GmbH. Never use the handlebar for carrying loads, such as children's vehicles or bags (other than the Handlebar Console available as an accessory).

Never pull the Croozer Kid with a motorised vehicle, such as a moped or scooter. This also applies to motorised bicycles with a maximum speed of more than 15 mph (25 km/h). Do not mount the hitch nut to a bicycle with a rear-wheel hub motor, unless this modification (the replacement of the original axle nut) is approved by the manufacturer of the bicycle and/or motor. Zwei plus zwei GmbH will not be liable for any damages resulting from non-compliance with these requirements.

Orientation and wording

Unless otherwise indicated, the terms right and left in this manual refer to the passenger's right or left when seated in the Croozer Kid, facing forward (i.e. relative to the direction of travel).

For simplicity, this manual generally refers to the child or passenger in singular form. It is understood, however, that the Croozer Kid for 2 will be carrying up to two children and the Croozer Kid for 1, one child.

For the sake of clarity, the Croozer Kid for 2 is shown in most of the photos and graphics used in this manual. However, all descriptions and instructions also apply to the Croozer Kid for 1 and, in this case, refer to a single seat.

Applicable standards

The following standards were taken into consideration: EN 15918:2011 and EN 1888:2012.

Safety Guidelines

Symbols and warnings



DANGER!

DANGER indicates a hazardous situation which, if not avoided, will result in death or serious injury.



WARNING!

WARNING indicates a hazardous situation which, if not avoided, could result in death or serious injury.



CAUTION!

CAUTION indicates a hazardous situation which, if not avoided, could result in minor or moderate injury.

NOTICE

NOTICE indicates a situation which, if not avoided, could result in damage to the Croozer Kid or the environment.

Tip: *In this manual, "Tip" indicates helpful advice about the use or maintenance of the Croozer Kid.*

Read and observe this manual

This manual contains information that is extremely important for the safe transport of your child. Therefore, it is essential that you read the entire manual carefully and follow the instructions closely. If you should experience difficulties understanding any of the information or instructions, please contact your Croozer dealer. Keep this manual handy at all times for future reference. If you loan or sell your Croozer Kid, pass on this manual to the new user. It is also vitally important that you read and observe the instructions provided in the manual of the towing bicycle.

Who can ride in the Croozer Kid?

The Croozer Kid can transport children from approx. 6 months to 6 years of age, with a maximum height of 46 inches (117 cm). All child passengers must be able to sit upright unassisted. Children who are not able to sit upright without support do not have fully developed muscles and could therefore experience injury when riding in the Croozer Kid. These children may only be transported in the Infant Sling that is available as an optional accessory. The Croozer Kid for 2 can carry one or two children, and the Croozer Kid for 1, only one child.

Who can ride the towing bicycle?

The minimum age for the rider of the towing bicycle in most countries of the EU is 16 years. In case of doubt, be sure to acquaint yourself with the applicable laws in the state or country where you plan to use the Croozer Kid.

Requirements for the towing bicycle

The towing bicycle must be approved by its manufacturer for pulling a trailer. This information can be found in the owner's manual of the bicycle. Furthermore, the towing bicycle must be in perfect working order and have strong, properly functioning brakes. The rear wheel of the towing bicycle must be equipped with an effective splashguard. Otherwise, the passenger could be injured by stones and other debris thrown up from the road. Motorised vehicles may not be used for pulling child trailers. The only exception to this rule is a pedelec. This special type of e-bicycle has an electric motor that delivers assist only when the rider pedals. In many countries, pedelecs legally qualify as bicycles. However, e-bikes with a maximum speed of more than 15 mph (25 km/h) may not be used for pulling the trailer. The towing bicycle should be equipped with a sturdy rear-mount kickstand to ensure safety when passengers are getting in and out of the trailer.

Be sure to familiarise yourself with the legal requirements that apply to towing bicycles in the country or state where you will be using the Croozer Kid.

The towing bicycle must have a 26" or 28" (559 or 622mm) rear wheel. This information can be found on the tyre sidewalls. The numbers 42-622, for example, indicate that the tyre has a width of 42 mm and a bead-seat diameter of 622 mm (28 inches).

Legal requirements for transporting children

Be sure to observe all laws that apply to the transport of children in child trailers. Some countries prohibit the transport of children in child trailers, and others prescribe certain age limits. In case of doubt, be sure to familiarise yourself with the legal requirements of the country in which you plan to use the Croozer Kid.

Before your first ride...

It is vitally important that you familiarise yourself with the Croozer Kid before you use it for transporting children. Prior to your first trip with passengers, Zwei plus zwei GmbH recommends taking a practice ride with the trailer in a calm, traffic-free area; load the trailer with cargo of approximately the same weight as the child or children you will be transporting, for example, by strapping a loaded backpack/rucksack into the child seat. This is a great way to acquaint yourself with the handling of the bicycle and the dimensions of the trailer.

Buckle up!

Children riding in the Croozer Kid must be strapped into the safety harnesses at all times. Follow the instructions provided in this manual for fastening the safety harnesses correctly. Children who are not properly secured in a safety harness could sustain life-threatening injuries in the case of accidents or sudden braking.

Looking after child passengers

Never leave children in the Croozer Kid unattended. It is the user's responsibility to ensure that the ventilation and temperature in the trailer is comfortable for the passengers at all times. Check on the passengers frequently to make sure they are safe and comfortable in the Croozer Kid.

Keep handlebar attached

Leave the handlebar attached to the Croozer Kid at all times. In the event of an accident, it acts as a roll bar, protecting the passengers.

Crushing hazard

When folding and unfolding the Croozer Kid, keep fingers and hands clear of all possible pinch points (e.g. movable frame parts and locking mechanisms).

Pulling the Croozer Kid as a Bicycle Trailer

Before each ride, check the following:

- Are the wheels securely attached?
- Are the locking mechanisms on both vertical frame tubes securely engaged?
- Are all security pins correctly inserted and locked? Check that none of the security pins are hanging freely from their straps.
- Check tyre pressure prior to each ride. We recommend riding with a tyre pressure of 1.5 to 2.5 bar (22-36 P.S.I.). Never use compressed air, e.g. from a gas/petrol station, to fill your tyres. The rapid airflow and high pressure can overinflate the tyres, causing the tube and/or tyre to burst.

Using the parking brake

When loading or unloading children, or when passengers are getting in or out of the trailer, the parking brake of the Croozer Kid must be engaged to prevent unintentional rolling.

Turning

Always reduce your speed to a walking pace when making turns with the Bicycle Trailer. Keep in mind that riding speed is often underestimated, especially on bikes with electric assist. When turning at high speeds, the increased centrifugal force can cause the trailer to skid or tip over and result in accidents with serious injury or death.

Riding downhill

Always reduce your speed when riding downhill. Riding at excessive speeds can cause the trailer to skid and result in accidents with serious injury or death.

Riding over curbs or uneven surfaces

Riding over a curb or other obstacle with only one wheel of the trailer could cause the trailer to tip over, resulting in accidents with serious injury or death. Empty trailers are especially susceptible to tipping. Therefore, if you have to ride over a curb or similar obstruction, always use extreme caution and ride at very low speeds. Never use the Croozer Kid on stairs or escalators.

Risk of injury from rotating parts

Always make sure that the child cannot reach the wheels of the Croozer Kid or the rear wheel of the towing bicycle. Touching wheels that are in motion could result in serious injuries.

Close the cover

When riding with the trailer, always close the mesh cover – or both covers – in order to protect the passenger from flying insects or small stones thrown up from the rear wheel of the towing bicycle, which can result in serious injuries for the passengers.

The vehicle's plastic windows and fabric cover offer only minimal protection against UV rays. Take the same precautions as you would outdoors to protect your child's skin from the harmful rays of the sun.

Being visible to others

Never use your Croozer Kid as a Bicycle Trailer without the safety flag mounted. The safety flag makes it easier for other road users to see you.

Carrying cargo

Never transport cargo items together with children on the seat or in the foot area. Cargo must be well secured in the rear cargo compartment to ensure that it cannot shift during transport. Loose cargo and overloading can change the handling of the Croozer Kid, making the vehicle more difficult to control. Furthermore, cargo items can fall against the seatback and injure the passenger. Never transport animals together with children in the Croozer Kid.

Never attach loads, such as children's vehicles or bags (other than the Handlebar Console available as an accessory), to the handlebar of the Croozer Kid, as doing so compromises the stability and handling of the vehicle, which can result in accidents with serious injury or death.

Stowing the safety wrist strap

The safety wrist strap required when using the fixed-wheel Stroller should never be removed from the handlebar. When using the vehicle as a Bicycle Trailer, the safety wrist strap should hang inside the trailer, beneath the cargo compartment cover.

Using the Croozer Kid as a fixed-wheel Stroller

The Croozer Kid with Stroller Kit is considered a walking stroller and is not approved for jogging or skating. Although the standard vehicle comes equipped with a Stroller Kit and meets all safety standards, we are required to provide this warning because there are factors other than the vehicle itself that may constitute a hazard.

Storage and transport

Never transport the Croozer Kid – even when folded – on the roof of a motor vehicle.

Never use or store the Croozer Kid at temperatures below –4°F (–20°C). Extremely low temperatures can cause the plastic windows to become brittle.

Assembly, maintenance and repair**Purchased condition and initial assembly**

If you have purchased the Croozer Kid from a shop, the retailer should install the front bumper, reflectors and brake shoes. If you ordered your Croozer Kid from an online or mail-order catalogue, we recommend having the initial assembly performed by a professional bicycle mechanic. Dealers are required to provide the customer with all important information on the use of the Croozer Kid.

Technical condition

Never use the Croozer Kid if it is not in perfect working order. The Croozer Kid must be periodically inspected for damage and/or wear to the wheels, hitch arm, frame, fabric body, security pins, quick-release mechanisms and safety harnesses. If any of these parts are found to be damaged, the Croozer Kid may not be used until the damage has been properly repaired, ideally by a professional bicycle mechanic.

It is critical that all maintenance work specified in the section “Croozer Kid Inspections and Maintenance” be performed in the specified intervals.

Using the Croozer Kid when it is not in perfect working order can result in accidents with serious injury or death.

Proper assembly and repair

The Croozer Kid must be properly assembled. Follow the instructions for the correct installation of the hitch nut, hitch arm, Stroller Kit components and Buggy wheel. When in doubt, contact your Croozer dealer. All repairs must be carried out to professional standards using only original Croozer parts, ideally by a professional bicycle mechanic. Incorrect installation or repair work could result in accidents with serious injury or death.

Suitable accessories and original spare parts

Only use accessories and original spare parts that have been recommended and approved by Zwei plus zwei GmbH. These are the only components that can be used safely with the Croozer Kid. When in doubt, consult a Croozer dealer. The use of non-approved accessories or

incompatible spare parts could result in accidents with serious injury or death. Zwei plus zwei GmbH cannot be held responsible for any damage resulting from the use of non-approved accessories or incompatible spare parts.

Changes and modifications

For safety reasons, no modifications or changes can be made to the vehicle.

Do not install attachment parts, such as luggage racks etc. Do not use a car seat or any type of seat or seat support that has not been approved by Zwei plus zwei GmbH. Do not install electric drive systems. Making modifications or changes to your Croozer Kid can result in accidents with serious injury or death. Furthermore, changes or modifications will void any warranty claims. Zwei plus zwei GmbH will not be liable for damages of any kind resulting from changes or modifications that have been made to the Croozer Kid.

Initial Assembly and Unfolding the Croozer Kid

If you have purchased the Croozer Kid from a shop, the retailer should install the front bumper, reflectors and brake shoes and sell the vehicle "ready to use". If you ordered your Croozer Kid from an online or mail-order catalogue, we recommend having the initial assembly performed by a professional bicycle mechanic. Dealers are required to provide the customer with all important information on the use of the Croozer Kid. If the initial assembly has been performed, you can skip the first few steps of this section.

If your Croozer Kid was not assembled prior to sale, then have the initial assembly performed by a professional bicycle mechanic or follow the assembly instructions below. If, for any reason, you do not feel completely confident about your ability to properly install these components, then have this work performed by a professional bicycle mechanic. Various tools are required for the assembly.



WARNING!

The Croozer Kid must be properly assembled. Improper assembly can result in accidents with serious injury or death.

Checking package contents

The Croozer Kid is packaged in a box for shipment. In order to minimise package size, the Croozer Kid is shipped in its folded state. All of the removable parts are removed for shipment. The front bumper, brake shoes and front reflectors are also shipped unattached.

1. Remove all packaging materials from the Croozer Kid and individual parts. Recycle all packaging material if possible. Keep the box for storage or transport.
2. Remove all individual parts from inside the Croozer Kid.

These parts include the front bumper and a package containing the front reflectors, mounting hardware, brake shoes and a hitch nut. Unfold the Croozer Kid before installing these parts.



Unfolding the Croozer Kid

- 1 Unbuckle the transport safety strap (1) at the rear of the Croozer Kid.
- 2 Tuck the strap (2) into the special strap-storage pocket under the cover.
- 3 Brace the lower part of the Croozer Kid frame with one hand while using your other hand to lift the top part of the frame.
- 4 Holding the upper frame tube in the raised position, pull the seat frame slowly and carefully back and towards you. At the same time, keep the right locking mechanism from getting trapped between the tubes of the seat frame and Croozer Kid frame by swinging it inwards.



CAUTION!

RISK OF PINCHING OR CRUSHING! There are pinch points between the seat frame and Croozer Kid frame, as well as between the locking mechanism and frame tube, that may cause painful injuries. Use caution to avoid these points when folding or unfolding the trailer.

NOTICE

Use caution and slow movements when pulling back the seat frame and swinging the right locking mechanism away from the frame tube. If the seat frame is pulled back too quickly or with excessive force, the locking pin of the right locking mechanism could damage the frame tube.

Tip: A new Croozer Kid will be slightly more difficult to unfold because the canvas is still stiff.

5. Once you have pulled back the seat as far as it will go, close the left locking mechanism (3) by pushing it outwards and snapping it onto the frame tube (4). Check that the red catch (5) has moved into place, completely covering the frame tube in the locking mechanism. Only then is the locking mechanism safely engaged.
6. After the left locking mechanism is engaged, close the right locking mechanism (6) by pulling the red slide button (7) towards you and pushing the locking mechanism onto the frame tube (8). The locking mechanism is safely engaged when the red catch (9) is completely covering the frame tube, and the locking pin (10) is inside the hole in the frame tube.

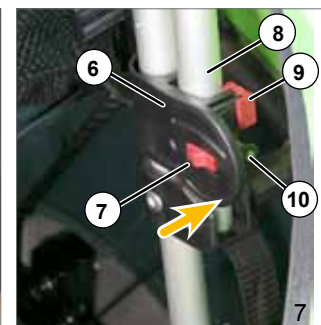

Initial Assembly and Unfolding the Croozer Kid

7. Check that both locking mechanisms are properly engaged. There should be no movement in the seat frame when you push against it.



WARNING!

If the locking mechanisms are not properly engaged, the frame of the Croozer Kid could collapse while riding, potentially resulting in serious injuries for the passenger. Furthermore, this situation could cause the rider of the towing bicycle to lose control, resulting in accidents with serious injury or death.

Installing the bumper, reflectors and brake shoes

Because packaging size is limited, the bumper, brake shoes and front reflectors of the Croozer Kid are shipped unattached. These parts are included in the scope of delivery and must be properly installed.

Box contents

The box with your Croozer Kid should contain the following items:

- bumper (1)
- package containing two short $\frac{1}{4}$ " Allen bolts with washers and locknuts (2), two long $\frac{1}{4}$ " Allen bolts with rubber washers (3), two front reflectors (5) with bolts (4), and two brake shoes (6) (one left and one right).
- The Croozer Kid also comes with a hitch nut (7), which will be mounted to the towing bicycle.

For the installation of the reflectors, bumper and brake shoes, the following tools are required: a $\frac{7}{16}$ " (11mm) open-end spanner/wrench, a Phillips screwdriver and a $\frac{5}{32}$ " (4mm) Allen key.

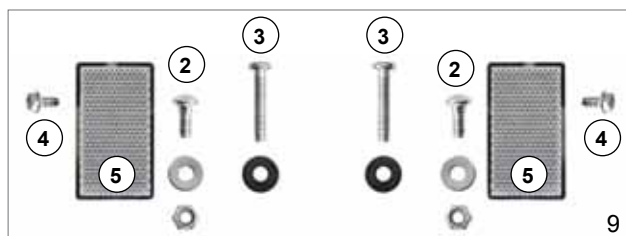
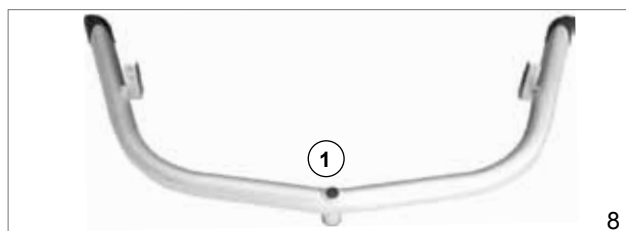

Mounting the front reflectors

1. Hold the reflector (5) against the mounting plate on the front bumper, positioning it so that the pin (9) on the back of the reflector fits through the lower hole of the mounting plate.
2. Insert the bolt (4) through the upper hole of the mounting plate, and fasten the reflector (5) by tightening the bolt with a Phillips screwdriver (8).
3. Repeat steps 1 and 2 to fasten the second front reflector to the other mounting plate on the bumper.

Mounting the bumper

1. Insert the two long Allen bolts (3) from inside through the holes in the front frame tube of the Croozer Kid.
2. Slide the rubber washers over the ends of the Allen bolts protruding through the front of the frame tube.
3. Place the bumper (1) onto the mounting plates on the sides of the frame, lining up the holes.

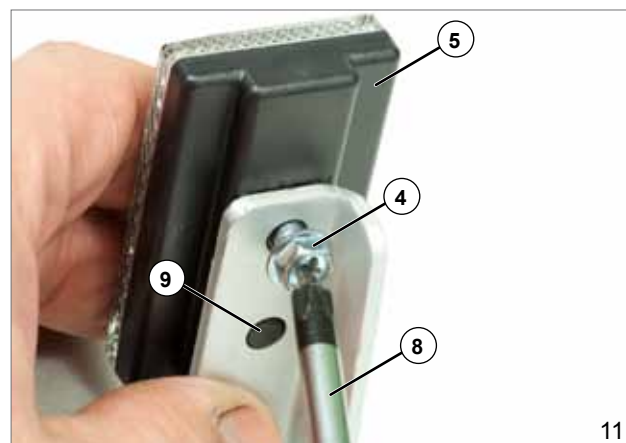

4. Screw the two long Allen bolts (3) into the threaded holes of the bumper, tightening lightly at first.
5. Insert one of the short Allen bolts (2) through the aligned holes of the bumper and the mounting plate.
6. Place a washer and locknut from below onto the end of the bolt, and tighten the nut lightly at first.
7. Repeat steps 5 and 6 to attach the other side of the bumper.
8. Adjust the position of the bumper as necessary to ensure that it is even and level; then tighten all bolts, using a 5/32" (4mm) Allen key and a 7/16" (11mm) open-end spanner/wrench.



Installing the brake shoes



WARNING!

It is vitally important that the brake shoes are correctly installed. Improperly installed brake shoes can cause the parking brake to malfunction. The parked Croozer Kid could roll away, resulting in accidents with serious injury or death.

1. Lay the trailer on its left side.

Tip: *The left brake shoe is marked with an "L", and the right brake shoe, with an "R".*

2. Remove the Allen bolt (1) in the right brake shoe using a 5/32" (4mm) Allen key.
3. Hold the right brake shoe (2) against the mounting plate (3) of the parking-brake mechanism.
4. Insert the Allen bolt (1) into the brake shoe, and tighten it using a 5/32" (4mm) Allen key.
5. Lay the trailer on its right side, and repeat steps 2-4 to install the left brake shoe.

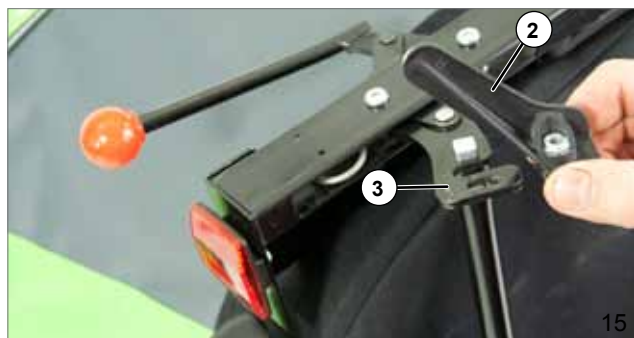

NOTICE

Be careful when tipping the trailer without wheels, as the entire weight of the chassis is resting on the brake shoes, making them especially susceptible to damage.

Initial Assembly and Unfolding the Croozor Kid

Now that the front bumper, reflectors and brake shoes are installed, and the Croozor Kid is unfolded with the locking mechanisms safely engaged, the wheels and handlebar with safety wrist strap can be mounted to complete the Chassis. Then, with the enclosed conversion kits, the Croozor Kid can be easily converted to a Bicycle Trailer, a swivel-wheel Buggy or a fixed-wheel Stroller.



Attaching and removing the wheels

The wheels of the Croozor Kid are equipped with push-button axles. By pressing the dust cap (1) on the wheel hub, the retaining balls (2) will retract within the axle to permit the attachment or removal of the wheel. The wheels cannot be attached or removed unless the dust cap is pressed in.



1. Check that the brake lever (3) is in the disengaged position. If not, pull back the lever to disengage the mechanism.
2. Use one hand to lift up the back of the Croozor Kid.
3. Press the dust cap (1) of the wheel hub with the marking "PUSH".
4. Insert the wheel axle (4) into the axle receiver (5) of the Croozor Kid, and release the dust cap.
5. Check whether the wheel is locked securely in the axle receiver by pulling firmly on the wheel. It should not be possible to remove the wheel without pressing on the dust cap.
6. Repeat steps 2-5 to attach the second wheel.



WARNING!

Wheels that have not been securely attached can fall off when riding, resulting in accidents with serious injury or death. After you have attached the wheels, it is vitally important that you check whether the axles are securely locked into the axle receivers by firmly pulling on the wheels. It should not be possible to remove the wheels without pressing on the dust cap.

7. Check the function of the parking brake by pushing the lever (3) forward. Both brake shoes should press firmly against the tyres. When the parking brake is engaged, it should not be possible to move the wheels.
8. To remove the wheels, follow these instructions in the reverse order.



Attaching and removing the handlebar with safety wrist strap

The handlebar has two functions. Firstly, it is used for pushing the Croozer Kid as a swivel-wheel Buggy or fixed-wheel Stroller. For this purpose, the handlebar can be mounted in either a high or a low position, depending on the height and preferences of the user. Secondly, the handlebar functions as a roll bar, protecting the passengers should the Croozer Kid tip over in the rare event of an accident.

1. If you are installing the handlebar for the first time, begin by removing the transport inserts (1) from the upper frame tubes.
2. Decide whether you would prefer to use the handlebar in the high (2) or low (3) position.
3. Slide the smaller loop of the safety wrist strap (4) over the handlebar, and insert both ends of the handlebar simultaneously into the upper frame tubes. Take care to align the tubes properly to keep them from jamming or getting stuck.

Tip: The ends of the new handlebar may stick somewhat when inserting them into the frame tube for the first time. If so, a light coating of silicon spray can help.

4. Push the rear flap of the cover slightly forward to locate the hole in the upper frame tube.
5. Insert the security pin (5) through the hole.
6. Snap the wire loop (6) of the security pin over the pin end protruding from the other side of the frame tube to lock it in place.
7. Repeat steps 4-6 for the other side of the handlebar.

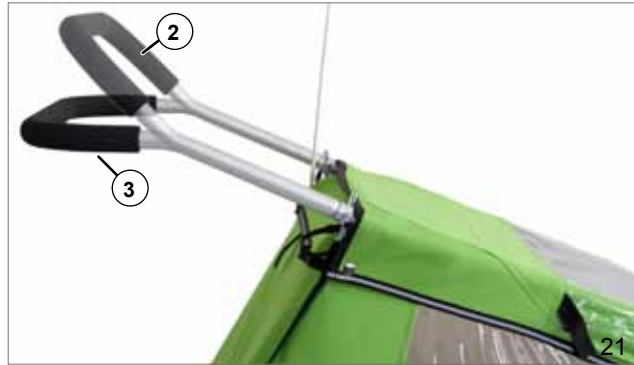

WARNING!

The handlebar must be secured with both security pins at all times. Otherwise, the handlebar could fall off when you are pushing it, and the Stroller or Buggy could roll away unintentionally, resulting in accidents with serious injury or death.

WARNING!

When the Croozer Kid is being used as a Bicycle Trailer, the handlebar must remain securely attached at all times. If the trailer should ever tip over, the handlebar acts as a roll bar, helping to prevent injuries.

Tip: When not in use, the safety wrist strap can hang inside the rear compartment area.

8. To remove the handlebar, e.g. for storage or transport, follow these instructions in the reverse order.



Converting the Croozer Kid to a Bicycle Trailer

If the Buggy wheel or Stroller wheel and wheel arms are mounted to the Croozer Kid, remove the respective components and lock the security pins into the appropriate holes.

NOTICE

Never leave the security pins hanging freely from their straps. They could get caught on passing objects and be pulled off, damaging the vehicle.

Installing and removing the hitch arm

The hitch arm is installed on the left side of the Croozer Kid (relative to the direction of travel).

Tip: *The first time you install the hitch arm, we recommend tipping the Croozer Kid onto its back end in order to have a better view of the parts when familiarising yourself with the procedure. Make sure that your working surface is clean and flat to avoid soiling and/or damaging the fabric body. Later, once you are familiar with the installation and removal procedures, you can install the hitch arm with the front of the Croozer Kid slightly raised.*

1. Lift the front of the Croozer Kid, or tip the frame onto its back end.
2. Open the wire loop of the security pin (1) in the hitch-arm attachment bracket, and pull the security pin out of the hole.
3. Hold the hitch arm (2) with the hole (4) facing upwards and the hitch arm at an approx. 45° angle to the attachment bracket (3).
4. Guide the retaining bolts (5) at the end of the hitch arm gently into the slots of the hitch-arm attachment bracket.
5. Then fold the hitch arm upwards into the hitch-arm attachment bracket until the bolts (5) of the hitch arm are fully engaged in the slots of the attachment bracket.

NOTICE

Do not let the strap of the security pin get caught between the hitch arm and attachment bracket as this could damage the strap.

6. Insert the security pin (1) through both holes of the hitch-arm attachment bracket.
7. Lock the security pin in place by snapping the wire loop over the pin end.

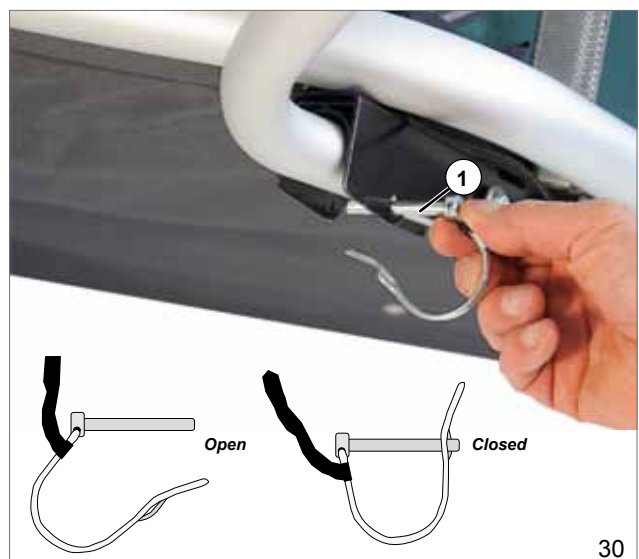

**WARNING!**

Always check that the wire loop of the security pin is snapped securely onto the pin end. If the security pin is not securely locked, the hitch arm could fall off while in use, resulting in accidents with serious injury or death.

8. To remove the hitch arm, follow these steps in the reverse order.

NOTICE

After removing the hitch arm, always lock the security pin back into the holes in the bracket. Never leave the security pins hanging freely from their straps. They could get caught on passing objects and be pulled off, damaging the vehicle.

Installing the hitch nut to the towing bicycle

The hitch assembly is mounted to the left side of the bicycle (relative to the direction of travel) and consists of two parts: a hitch connector on the hitch arm of the Croozer Kid and a hitch nut, which is mounted to the rear axle of the towing bicycle. The hitch nut is installed in place of the axle nut. Three versions of the hitch nut are available, depending on the type and size/threading of the rear axle of the towing bicycle:

- Version 1: For a quick-release with 5mm skewer (M5)
- Version 2: For a 10mm solid axle threaded 25.4tpi (M10 x 1)
- Version 3: For a 3/8" solid axle threaded 26tpi

However, before using a bicycle for pulling the Croozer Kid, you must first check whether it is suitable for use as a towing bicycle. This information can be obtained from the bicycle manufacturer, a bicycle shop or the owner's manual of the bicycle.

Tip: Your Croozer Kid comes with a hitch nut for a quick-release axle with a 5mm (M5) skewer. Other hitch nut versions can be purchased from Croozer dealers. For older bicycles, an adapter is available that can be used for installing the hitch nut to various solid axles.

**WARNING!**

It is vitally important to confirm that the towing bicycle is suitable for pulling trailers. Pulling a trailer with a bicycle that has not been approved by its manufacturer for use as a towing bicycle can result in frame breakage or other material damage. This could cause accidents with serious injury or death.

If you are not completely confident about your ability to install the hitch nut correctly, please consult with, or have the installation performed by, a professional bicycle mechanic.

**WARNING!**

It is vitally important that the hitch nut be properly installed. An improperly installed hitch nut could come loose while riding and cause accidents with serious injury or death.

Converting the Croozer Kid to a Bicycle Trailer

Installing the hitch nut to a bicycle with a quick-release axle

The quick-release lever must be positioned on the right side of the bicycle (relative to the direction of travel). If the lever is on the left side, the quick-release assembly must be removed and reinserted from the right side. Be sure to follow the applicable instructions in the owner's manual of the bicycle and/or consult a professional bicycle mechanic.

1. Disengage the quick release of the rear wheel by lifting the lever. Often, the open position is indicated on the lever by the word "OPEN". In this case, when the word "OPEN" can be seen, the lever is in the open position.

2. Remove the tension-adjusting nut (2) of the quick-release assembly by turning the nut anticlockwise. Use caution: the spring located just beneath the nut is under tension and could fly off when removing the nut.



3. Without removing the spring on the end of the quick-release skewer, thread the hitch nut (3) onto the skewer in place of the tension-adjusting nut. Tighten the hitch nut until you feel a slight resistance.

4. Check that the rear wheel is properly aligned, adjusting the position if necessary; then close the quick-release lever. Often, the closed position is indicated on the lever by the word "CLOSE". In this case, when the lever side marked "CLOSE" can be seen, the lever is in the closed position. If the hitch nut has been tightened the proper amount, you will be able to feel the resistance increase when the lever is about halfway closed, i.e. parallel to the axle. The adjustment is correct if you can fully close the lever but with considerable force. In the closed position, the lever should be parallel to the frame, i.e. it should not stick out to the side.



5. Check whether the quick-release is securely engaged by trying to rotate the endcap of the mechanism (where the lever is attached) without opening the lever. If the endcap is loose enough to rotate, then the clamping force is inadequate. In this case, open the lever, and tighten the hitch nut half a turn clockwise. Repeat steps 4 and 5.



If it is impossible to push the quick-release lever into the closed position, then open the lever, and unscrew the hitch nut half a turn anticlockwise. Repeat steps 4 and 5.

6. Hold the rear wheel with both hands, and try to rock it back and forth to check that the quick-release mechanism is securely fastened. If there is any play in the wheel, repeat steps 4 and 5.

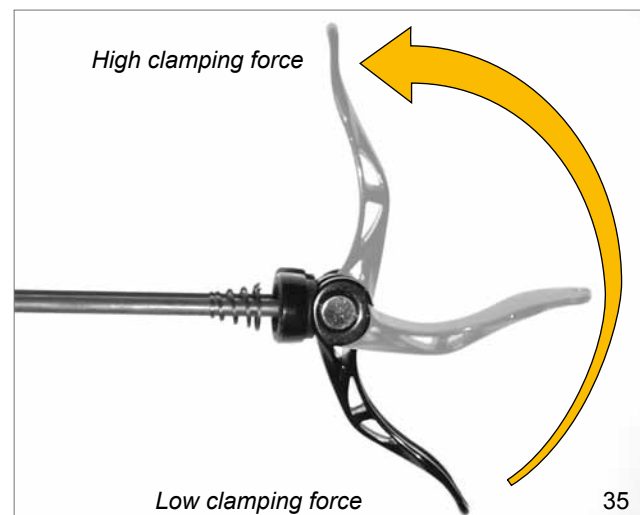

**WARNING!**

It is vitally important that the rear wheel with the hitch nut be installed correctly. Riding with an incorrectly installed rear wheel could result in accidents with serious injury or death. Follow the instructions and warnings given in the owner's manual of the towing bicycle. When in doubt, consult a professional bicycle mechanic.

Installing the hitch nut to a bicycle with a solid axle

For installation to a solid axle, two different hitch nut versions are available: for M10 x 1 and 3/8" x 26tpi axles.

NOTICE

If you are not sure whether you have the right hitch nut for your bike, consult a professional bicycle mechanic for installation. Attempting to install an incompatible hitch nut to the axle could destroy the threads of the axle or the hitch nut.

1. Remove the nut on the left side of the solid axle by turning it anticlockwise.
2. Leave the existing washer on the solid axle, and thread the hitch nut onto the end of the axle in place of the axle nut.

**WARNING!**

It is vitally important that you leave the existing washer on the axle. This washer prevents the axle from rotating in the dropouts. Riding without the axle washer can result in accidents with serious injury or death.

3. Check that the rear wheel is properly centred, adjusting the position if necessary; then tighten the hitch nut using the tightening torque specified in the owner's manual of the bicycle.

**WARNING!**

The rear wheel must be properly attached after the hitch nut has been installed. Riding with an improperly installed rear wheel can result in accidents with serious injury or death. Follow the instructions and warnings given in the owner's manual of the towing bicycle. When in doubt, consult a professional bicycle mechanic.

Tip: Rohloff hubs with solid axles, SRAM iMotion hubs and Shimano derailleur hubs with solid axles are usually threaded M10 x 1.

All Shimano gear hubs (Nexus and Alfine) use a 3/8" x 26tpi axle. For older bicycles, you will need an adapter for attaching the hitch nut to your axle. These adapters are available from Croozer dealers.



Converting the Croozer Kid to a Bicycle Trailer

Installing the safety flag

The safety flag makes it easier for other road users to see the Croozer Kid, increasing your child's safety, as well as your own.

There is a hole on the left side of the upper frame tube for the attachment of the safety flag. There is also a slot in the cover at this site.

1. Assemble the flag pole (1) by connecting the two sections of the pole.
2. Pull open the slot in the cover to expose the hole (2) in the frame tube.
3. Slide the pole of the safety flag as far as it will go into the hole (2) in the upper frame tube.



WARNING!

When pulling the Croozer Kid as a Bicycle Trailer, the safety flag must be properly mounted at all times. If the safety flag is not properly mounted, other road users may fail to see the Croozer Kid, which could result in accidents with serious injury or death.



Converting the Croozer Kid to a Buggy

If the hitch arm or Stroller Kit (wheel and wheel arms) has been mounted to the Croozer Kid, remove the respective components and lock the security pins into the appropriate holes

NOTICE

Never leave the security pins hanging freely from their straps. They could get caught on passing objects and be pulled off, damaging the vehicle.

Installing the Buggy wheel

Tip: *The first time you install the Buggy wheel, we recommend tipping the Croozer Kid onto its back end in order to have a better view of the parts when familiarising yourself with the procedure. Make sure that your working surface is clean and flat to avoid soiling and/or damaging the fabric body. Later, once you are familiar with the installation and removal procedures, you can install the Buggy wheel with the front of the Croozer Kid slightly raised.*

1. Lift the front of the Croozer Kid, or tip the frame onto its back end.
2. Open the wire loop of the security pin (1) in the middle of the front bumper, and remove the security pin.
3. Insert the Buggy wheel (2) into the wheel socket (3) in the middle of the front bumper.
4. Push the security pin (1) through the hole in the Buggy-wheel socket (3).
5. Snap the wire loop of the security pin (1) over the pin end protruding from the other side of the frame tube to lock it in place.



CAUTION!

Always check that the wire loop of the security pin is snapped securely onto the pin end. If the security pin is not securely locked, the Buggy wheel could fall off while in use, resulting in accidents with injuries.

6. To remove the Buggy wheel, follow these steps in the reverse order.

NOTICE

After removing the Buggy wheel, be sure to lock the security pin back into the holes in the wheel socket. Never leave the security pin hanging freely from its strap. It could get caught on passing objects and be pulled off, damaging the vehicle.

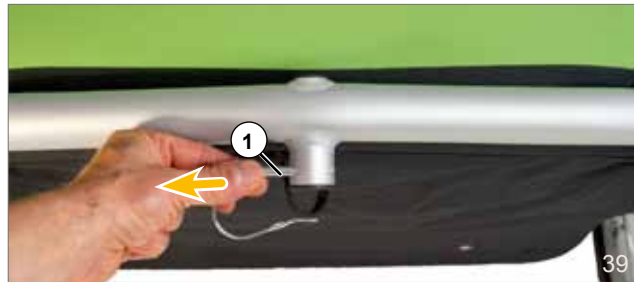

Converting the Croozer Kid to a Stroller

If the hitch arm or Buggy wheel has been mounted to the Croozer Kid, remove the respective components and lock the security pins into the appropriate holes.

NOTICE

Never leave the security pins hanging freely from their straps. They could get caught on passing objects and be pulled off, damaging the vehicle.

Attaching the wheel arms

The Stroller Kit, which converts the Croozer Kid to a walking stroller, consists of two wheel arms, one wheel and a safety wrist strap. The wheel arms are attached in the same way as the hitch arm. One wheel arm is mounted to the hitch-arm attachment bracket on the left side of the frame, and the other, to the wheel-arm attachment bracket on the right side of the frame (relative to the direction of travel).

Tip: *The first time you install the Stroller Kit, we recommend tipping the Croozer Kid onto its back end in order to have a better view of the parts when familiarising yourself with the procedure. Make sure that your working surface is clean and flat to avoid soiling and/or damaging the fabric body. Later, once you are familiar with the installation and removal procedures, you can install the wheel arms and Stroller wheel with the front of the Croozer Kid slightly raised.*

1. Lift the front of the Croozer Kid, or tip the frame onto its back end.
2. Open the wire loop of the security pin (1) in the hitch-arm attachment bracket, and remove the security pin. Follow the same steps for removing the security pin in the wheel-arm attachment bracket on the other side of the frame.

Tip: *The two wheel arms are identical. Position each arm so that it curves inward.*

3. Hold the left wheel arm (2) at an approx. 45° angle to the hitch-arm attachment bracket.
4. Guide the retaining bolts (3) of the left wheel arm gently into the slots of the hitch-arm attachment bracket.
5. Then fold the wheel arm upwards into the hitch-arm attachment bracket until the bolts of the wheel arm are fully engaged in the slots of the attachment bracket.

NOTICE

Do not let the strap of the security pin get caught between the wheel arm and attachment bracket as this could damage the strap.



6. Insert the security pin (1) through both holes of the hitch-arm attachment bracket.
7. Lock the security pin in place by snapping the wire loop over the end of the pin.
8. Repeat steps 3 to 7 for the right wheel arm.



WARNING!

Always check that the wire loops of the security pins are snapped securely onto the pin ends. If the security pins are not securely locked, the wheel arms could fall off while in use, resulting in accidents with serious injury or death.

Installing the Stroller wheel

1. Open the quick-release of the Stroller wheel by lifting the quick-release lever (6) until the lever side marked "OPEN" is facing outwards, away from the wheel.
2. Slide the Stroller wheel (2) as far as possible into the slots in the dropouts of the wheel arms. The flattened surfaces (3) on the axle must be lined up with the slots in the dropouts.

Tip: If you have difficulties sliding the Stroller wheel into the slots in the dropouts, then loosen the tension-adjusting nut of the quick-release by turning it a few turns anticlockwise and try again.

3. With the quick-release lever in the open position, tighten the tension-adjusting nut (4) by turning it clockwise until you feel a slight resistance.
4. Close the quick-release by moving lever (1) towards the wheel arm until the lever side marked "CLOSE" is facing outwards. If the tension-adjusting nut has been tightened the proper amount, you will be able to feel the resistance increase when the lever is about halfway closed, i.e. parallel to the axle. The adjustment is correct if you can fully close the lever but with considerable force. In the closed position, the lever should be parallel to the dropout (5) of the wheel arm, i.e. it should not stick out to the side.
5. Check whether the quick-release is securely engaged by trying to rotate the endcap of the mechanism (where the lever is attached) without opening the lever.

If the endcap is loose enough to rotate, then the clamping force is inadequate. In this case, open the lever, and tighten the tension-adjusting nut (4) half a turn clockwise. Repeat steps 4 and 5.

If it is impossible to push the quick-release lever (1) into the closed position, then open the lever, and unscrew the tension-adjusting nut half a turn anticlockwise. Repeat steps 4 and 5.

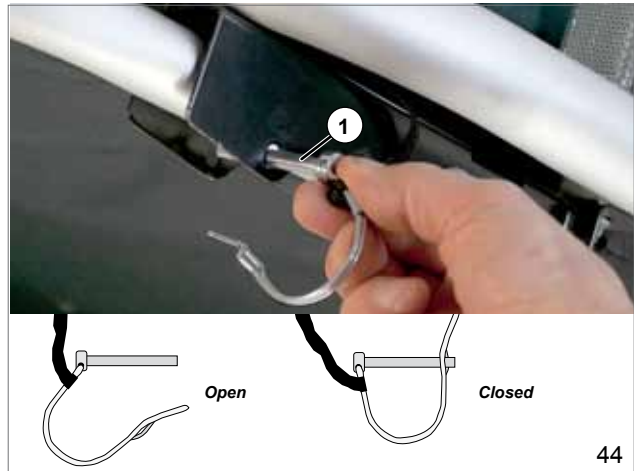

Converting the Croozer Kid to a Stroller

6. Hold the Stroller wheel with both hands, and try to rock it back and forth to check that the quick-release mechanism is securely fastened. If there is any play in the wheel, repeat steps 4 and 5.



WARNING!

It is vitally important that the Stroller wheel and wheel arms be installed properly. Operating the Croozer Kid with improperly installed Stroller Kit components could result in accidents with serious injury or death. When in doubt, consult a professional bicycle mechanic.



WARNING!

The Croozer Kid with the Stroller Kit installed is considered a walking stroller and is not approved for jogging or skating. Jogging or skating with the Stroller could result in accidents with serious injury or death.

Tip: *Although the Croozer Kid with the Stroller Kit installed meets high safety standards, we are required to provide this warning because there are factors other than the vehicle itself that may constitute a hazard. Zwei plus zwei GmbH will not be liable for damages of any kind resulting from the use of the Croozer Kid for jogging or skating.*

Tip: *If you notice that the Stroller is pulling to the right or left during use, check whether the Stroller wheel is straight and the axle is properly seated in the drop-outs. If not, realign the wheel.*

7. To remove the Stroller wheel and wheel arms, follow these steps in the reverse order.

NOTICE

After removing the wheel arms, lock the security pins back into the holes in the brackets. Never leave the security pins hanging freely from their straps. They could get caught on passing objects and be pulled off, damaging the vehicle.

Using the safety wrist strap

To prevent the Croozer Kid from accidentally slipping out of your hands and rolling away, for example when pushing the Buggy or Stroller downhill, it is vitally important that you keep the safety strap (1) around your wrist at all times. Use the rubber ring to adjust the loop size to fit snugly around your wrist.

The safety wrist strap is usually mounted with the handlebar. Before using the Buggy or Stroller version of the Croozer Kid, check that the safety wrist strap has been mounted. If the handlebar has been installed without the safety strap, remove the handlebar and reinstall it with the safety wrist strap attached, following the instructions given in the section "Attaching and removing the handlebar with safety wrist strap" on page 13.



WARNING!

When using the Stroller, it is vitally important that you keep the safety wrist strap fastened securely around your wrist at all times. Otherwise, the handlebar could slip out of your grip and roll away, resulting in accidents with serious injury or death.



Using your Croozer Kid

Engaging and disengaging the parking brake

The parking brake locks the wheels of a parked or stopped Croozer Kid to prevent it from rolling away. Never use the parking brake to slow down the Stroller or Buggy. Always engage the parking brake in the following situations:

- when releasing the handlebar of a parked/stopped Stroller or Buggy
- when loading/unloading children or helping a child into or out of the Stroller, Buggy or Bicycle Trailer
- to keep the Croozer Kid from rolling away from you when folding the frame

The parking brake is operated by a lever behind the right wheel of the Croozer Kid. When the parking brake is engaged, both wheels are locked.

1. To engage the parking brake, push the lever (1) forward until both brake shoes (2) are pressing firmly against the tyres.
2. Give the Croozer Kid a gentle push and pull to check that the brake is correctly engaged.
3. To release the parking brake, pull the lever (1) back as far as it will go. When the brake is correctly disengaged, neither of the brake shoes (2) will be in contact with the tyres, and the Croozer Kid wheels will be able to move freely.



WARNING!

Always set the parking brake when releasing the handlebar of a parked/stopped Stroller or Buggy, and check that the wheels are securely locked by giving the Croozer Kid a gentle push and pull. If the parking brake is not correctly engaged, the vehicle could roll into harm's way, resulting in accidents with serious injury or death.



WARNING!

Always set the parking brake when loading/unloading children or helping a child into or out of the Croozer Kid, and check that the wheels are securely locked by giving the Croozer Kid a gentle push and pull. If the parking brake is not securely engaged in this situation, the vehicle could roll away, resulting in serious injuries to the passengers.

NOTICE

Never use your foot for operating the parking brake lever. Doing so could damage the braking mechanism.

After releasing the brake, always check that the brake shoes are no longer pressing against the tyres. Never pull the Bicycle Trailer or push the Stroller or Buggy with the parking brake engaged, as doing so could damage the brake shoes or tyres.

Using your Croozer Kid

Opening and closing the cover

The two-in-one cover consists of a transparent plastic window (1), which protects the passenger from wind and light rain, and a mesh cover (2) beneath it. The plastic window can be rolled up by itself or together with the mesh cover and is secured at the top with elastic loops (3).

When unrolled, the mesh cover or both covers together are secured by Velcro tabs (4) on the lower frame.



WARNING!

When riding with the trailer, always close the mesh cover – or both covers – to protect passengers from insects (e.g. getting into children's eyes) and prevent small stones and other road debris from flying into the passenger compartment and injuring passengers.

Tip: For stronger rain, we recommend using the additional Rain Cover, which is available as an accessory.



Loading and unloading passengers

When loading or unloading the child or, in the case of older children, when the passengers are getting in or out of the seat, the parking brake of the Croozer Kid must be engaged to prevent unintentional rolling. In addition, when you are using the Croozer Kid as a Bicycle Trailer, the towing bicycle must be safely and securely supported to prevent it from falling.

1. Open the cover, roll it up, and secure it at the top, using the elastic loops (3).
2. If you are near traffic, have the child get in from the side that is away from the traffic if possible. When using the Croozer Kid as a Bicycle Trailer, passengers should climb in from the right side (with respect to direction of travel), so that they do not have to step over the hitch arm. Always assist children as they enter and exit the passenger compartment.

NOTICE

Never allow the child to sit, stand or lean on the hitch arm or wheel arms, as doing so could damage these parts.



Fastening and unfastening the safety harness



WARNING!

When using the Croozer Kid to transport children who are not able to sit upright unassisted or babies under 6 months of age, you must use the Infant Sling, which is available as an accessory. The seats and safety harnesses are designed for older children. In dangerous situations, a baby could slip out from under the safety harnesses, resulting in serious injury or death.

Tip: For babies between 1 and 10 months of age, use the Croozer Infant Sling, which is available as an accessory.

1. Make sure that all straps are unbuckled; then place the child in the seat.
2. Place both shoulder straps over the child's shoulders.
3. Place the crotch strap between the child's legs.
4. Clip the end of the crotch strap (1) into the lower, middle buckle of the padded harness. You should hear a click and be able to see that the buckle is correctly fastened.
5. Clip the ends of the two shoulder straps (2) into the upper buckles of the padded harness. You should hear a click and be able to see that the buckles are securely fastened.
6. Clip the ends of both lap belts (3) into the lower, side buckles of the padded harness. You should hear a click and be able to see that the buckles are securely fastened.



WARNING!

When riding in the Croozer Kid, your child must be strapped securely into the safety harness at all times. Always use the lap belt and shoulder straps in combination with the crotch strap. Otherwise, in dangerous situations, the child could slip out from under the safety harness, resulting in serious injury or death.



WARNING!

Failure to adjust the straps of the safety harness properly or to fasten the buckles correctly could result in accident and serious injury or death.

7. When unfastening the harness, it is possible to leave the crotch strap (1) attached to the padded harness and only unfasten the two shoulder-strap (2) and lap-belt buckles (3).



Using your Croozer Kid

Adjusting the safety harness

The Croozer Kid is equipped with 5-point safety harnesses.

1. Make sure that the harnesses are unbuckled; then place the child in the seat.
2. Slide the triglide adjusters up or down to adjust the height of the shoulder straps.
3. Adjust the lengths of all straps by tightening or loosening the Ladderloc adjuster buckles (1).
4. Adjust the tension of all straps so that the child is held snugly but comfortable in the harness.



WARNING!

The shoulder straps must fit comfortably yet snugly over the passenger's shoulders to ensure that the passenger is held securely in the seat. If the straps are too loose, the safety harness may not be able to hold the child securely, and in the event of an accident the child could slip out, resulting in serious injury or death. Straps that are too tight can cause discomfort to the passenger.

Adjusting the head pads

The top section of the seatback has Velcro strips for attaching the head pads (5). The position of the head pads can be adjusted to the height of the child.

1. Pull off the head pad.
2. Press the head pad onto the Velcro strips of the seatback at the appropriate height.

Tip: You can remove the head pads for a more comfortable sitting position when your child is wearing a helmet.



Transporting cargo

Load capacity and cargo compartments

The Croozer Kid has a large cargo compartment (1) behind the seat for holding your gear and essentials. The cargo compartment has an inside pocket (2), which can be used for stowing the Buggy wheel when not in use. In the passenger compartment of the Croozer Kid, beside the seats, are two mesh pockets (3) for smaller take-along items, such as drinking bottles, dummies/pacifiers, sunglasses etc.

Tip: In addition, we recommend using the optional Handlebar Console for additional cargo capacity with the Stroller or Buggy.



However, when transporting cargo, never exceed the weight limits specified below.

Maximum Weight of the Passengers	
Croozer Kid for 1	33 lbs (15 kg) max. 1 child
Croozer Kid for 2	2 x 33 lbs (2 x 15 kg) max. 2 children
Load Capacity: Cargo Areas*	
Rear cargo compartment	max. 11 lbs (5 kg)
Handlebar Console (accessory)	max. 4.4 lbs (2 kg)
* Weight limits only apply if the hitch-arm load is within the specified range of 6.6 to 17.6 lbs (3-8 kg). See page 28.	



WARNING!

NEVER OVERLOAD THE CROOZER KID. Doing so can severely affect the Croozer Kid's handling and cause accidents with serious injury or death.



WARNING!

Never transport cargo items together with children on the seat or in the foot area. The cargo could shift during transport and injure the Croozer Kid passengers.



WARNING!

Cargo in the rear cargo compartment must always be well secured to ensure that it cannot shift during transport. Loose cargo can change the handling of the Croozer Kid, which could cause accidents with serious injury or death. Furthermore, loose cargo items can fall against the seatback when braking and injure the passengers.

Using your Croozer Kid

Proper weight distribution and hitch-arm load

For safe handling, the weight on the hitch connector should be between 6.6 and 17.6 lbs (3 and 8 kg); the hitch-arm load (nose weight) is associated with an even distribution of weight in the trailer. If the centre of gravity is too far forward, the hitch connector will be overloaded. If the centre of gravity is too far behind the wheels, the rear wheel of the towing bicycle could lose traction, especially when making turns. If the centre of gravity is too far right or left, the trailer has a stronger tendency to tip over when making turns. Check the weight on the hitch connector before using the Croozer Kid as a Bicycle Trailer.

Follow these steps, using your bathroom scales, to determine the weight on the hitch connector:

1. Place your bathroom scales beside the hitch arm of the loaded and unhitched trailer.
2. Step onto the scales and make a note of your weight.
3. Now lift the hitch connector of the hitch arm about 1 foot (30 cm) off the ground.
4. The weight shown on the scales should be 6.6 to 17.6 lbs (3 - 8 kg) more than your own weight.



WARNING!

Never overload the trailer and never ride with a hitch-arm load that is outside the specified range of 6.6 to 17.6 lbs (3 - 8 kg). Always distribute the load evenly. Failure to do so could compromise the handling properties and cause accidents with serious injury or death.



WARNING!

Never use the handlebar for carrying loads, such as children's vehicles or bags (other than the Handlebar Console available as an accessory). Loading the handlebar compromises the stability and handling of the vehicle, which could result in accidents with serious injury or death.



Hitching the Croozer Kid to the Towing Bicycle



WARNING!

It is vitally important that you check whether the towing bicycle has been approved by its manufacturer for pulling a trailer. Towing a trailer with an unsuitable bicycle can result in frame breakage and accidents with serious injury or death.

Never hitch the trailer with passengers inside.

1. Lift the hitch arm of the Croozer Kid, and push the hitch connector (1) as far as it will go onto the hitch nut (2) that has been installed on the towing bicycle.
2. Insert the security pin (3) attached to the end of the hitch arm through the hitch connector.
3. Snap the wire loop (4) of the security pin over the pin end protruding from the other side of the hitch connector to lock it in place.
4. Check whether the hitch connector is securely fastened to the towing bicycle.



WARNING!

Always check that the wire loop of the security pin is snapped securely onto the pin end. If the security pin is not securely locked, the hitch arm could fall off the towing bicycle while riding, resulting in accidents with serious injury or death.

5. Wrap the hitch-arm safety strap (5) around the chainstay, and clip it to the D-ring (6) on the hitch arm. Make sure there is no danger of the hitch-arm safety strap (5) getting caught in the spokes or disc brakes of the towing bicycle.



WARNING!

Never pull the Croozer Kid as a Bicycle Trailer without the hitch-arm safety strap securely fastened to the towing bicycle. The safety strap ensures that the trailer would remain connected to the towing bicycle if the hitch connector were to fall off the hitch nut. Failure to use the safety strap as specified above could cause accidents with serious injury or death.



WARNING!

Never leave the Buggy wheel attached when using the Croozer Kid as a Bicycle Trailer. The Buggy wheel could get caught on obstacles as you pass, resulting in accidents with serious injury or death.



Special considerations when riding with the Bicycle Trailer

Speed

When pulling the Croozer Kid, never ride faster than the trailer's maximum allowable speed of 15 mph (25 km/h). Always reduce your speed to a walking pace when turning. Keep in mind that riding speed is often underestimated, especially on bikes with electric assist, which require less muscle power.



WARNING!

Riding too fast could cause the trailer to skid or even tip over, resulting in accidents with serious injury or death.

Load capacity

Never transport more than the specified load capacity (passengers + cargo). And never ride with less than 6.6 lbs (3 kg) or more than 17.6 lbs (8 kg) of weight on the hitch connector (nose weight). See section "Transporting cargo" on page 27.



WARNING!

Never overload the Croozer Kid. Excessive weight will have a significant effect on the Croozer Kid's handling, which could result in accidents with serious injury or death.

Riding in conditions of poor visibility

If you plan to use the Croozer Kid as a Bicycle Trailer at night, dusk or dawn – or when visibility is in any way reduced – the trailer must be equipped with a lighting system. Battery-powered LED lights, for example, are suitable lighting options.

There are two taillight-mounting loops sewn onto the rear cover, near the top, for the attachment of taillights. For both one-seaters and two-seaters, a taillight is attached to the mounting loop on the left side in countries with right-hand traffic (and on the right side in countries with left-hand traffic).

For two-seaters, a white headlight is mounted on the left side of the front bumper in countries with right-hand traffic (and on the right side in countries with left-hand traffic), in addition to the taillight.



67



WARNING!

Never use a trailer without lighting at night, dusk or dawn – or whenever visibility is in any way reduced. Other road-users may not be able to see you, which could result in accidents with serious injury or death.

Adult supervision



WARNING!

Never leave a child in the trailer unattended, not even briefly. In your absence, hazardous, unforeseen situations could arise.

Tips for the towing bicycle

- We recommend using a towing bicycle with multiple gears. The more speeds the bicycle has, the easier it will be to find the appropriate gear, for example, when starting, climbing hills and riding with a headwind.
- The towing bicycle must have two strong, independently operated brakes that are not only in perfect working order but also work effectively in wet weather conditions. This is vitally important, as the brakes must be able to stop the bike with the additional weight of the trailer.
- The towing bicycle must have a sturdy, rear-mount kickstand able to hold the bicycle firmly upright to guarantee safety and comfort when loading and unloading children. Single-legged kickstands mounted in the middle of the bicycle, under the bottom bracket, are NOT suitable because the weight of the hitched bicycle trailer, which rests on the chainstay, would make the parked bicycle unstable. Consult a bicycle shop for choosing the right kickstand.
- We recommend riding with a rear-view mirror on the towing bicycle. A rear-view mirror makes it easier to check on passengers in the trailer and keep an eye on the vehicles behind you so that you can react appropriately. Always ride defensively.
- The towing bicycle should have a long rear fender with a mudflap in order to protect the passenger from stones and other road debris that could be thrown up by the rear tyre and to avoid soiling the body or interior of the trailer.

Guidelines and tips for riding with a trailer and children

- When pulling a loaded trailer, the handling, balance and performance of the towing bicycle will be affected, especially when starting, braking, turning and riding downhill. Take adequate time to familiarise yourself with the Croozer Kid before transporting children. Prior to your first ride with children, we recommend taking a practice ride with the trailer in a calm, traffic-free area; load the trailer with cargo of approximately the same weight as the child or children you will be transporting, for example, by strapping a loaded backpack/rucksack into the child seat. This is a great way to acquaint yourself with the handling of the bicycle and the dimensions of the trailer.
- The safety flag on the long, vertical pole will make you more visible to other road-users. Never ride without the safety flag properly mounted.
- Always ride with the cover closed to protect passengers from road debris and flying insects.
- Cyclists should always use available bike paths or lanes, even when pulling a trailer. Be especially careful when riding on narrow bike paths or lanes, as well as on paths and trails with two-way traffic. The trailer is generally wider than the handlebars of the towing bicycle. In addition, most trailers will not be centred behind the towing bicycle. Reduce your speed in places where navigation is especially challenging; and if you are ever in doubt about whether the trailer will be able to fit through an opening, dismount and push the bike and trailer through.

Using your Croozer Kid

- The trailer requires a wide turning radius in both directions. Do not turn sharply. When turning left, keep in mind that the angle between the rear wheel of the towing bicycle and the hitch arm of the trailer must never be greater than 90°. Turning at sharper angles could damage the hitch connector. Be extremely cautious when turning right, as extreme right turns can cause the wheel to hitch arm, potentially damaging the hitch arm and/or the rear wheel of the towing bicycle. .
- Reduce your speed when riding on paths or streets with bumps or uneven surfaces to keep the ride as smooth and safe as possible for your passengers. Reduce your speed when turning. Otherwise the centrifugal force could cause the trailer to tip over.
- Be cautious, patient and attentive when riding with your child. The first few trips should be short and easy, to give your child time to get used to riding in the trailer.
- Children in the Bicycle Trailer should wear a helmet at all times. In the case of an accident, a helmet will prevent or reduce head injuries. In some countries, the use of helmets is required by law.
- Dress passengers appropriately and check frequently to make sure they are comfortable in the trailer, with adequate ventilation. Under the rain cover, the passenger compartment can become warm more quickly than otherwise, especially in direct sunlight. However, in colder weather, children sitting inactively in the trailer will feel colder and need more insulation than the person who is pedalling the towing bicycle. In colder temperatures, be sure to dress them in warm clothing and, if necessary, use a blanket, such as the Cosy Blanket or Bunting Bags available as accessories. You will find a list of Croozer accessories in the back of this manual.
- Keep your passengers' needs and well-being in mind: always take along small toys so that your child does not get bored. And when planning longer trips, keep in mind that your child will require frequent breaks. Be attentive to your child at all times, especially when riding over bumpy surfaces. In these situations, ride slowly and cautiously.
- The Baby Supporter available as an accessory from Croozer dealers gives your child additional support in the passenger seat.
- If you are planning a cycling trip with the trailer in another country, be sure to familiarise yourself in advance with the legal requirements that apply in the country or countries you intend to visit. Some countries do not permit the transport of children in bicycle trailers, and others impose certain age restrictions for the child passenger.
- The equipment legally required for bicycle trailers varies from country to country, and sometimes even from state to state. Be sure to observe and comply with the laws that apply in the country or state you will be using the Croozer Kid.

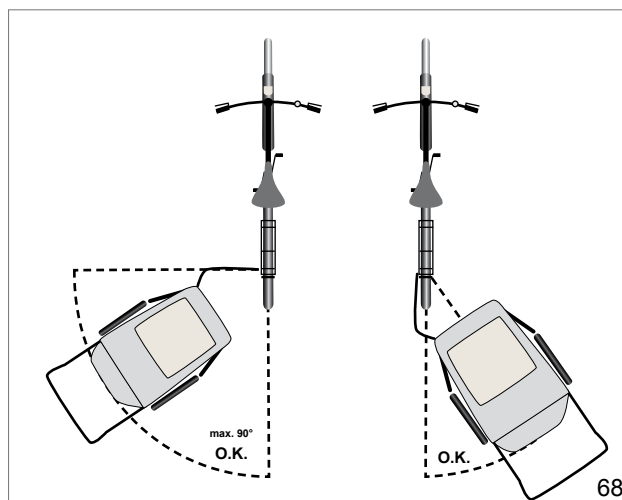

Special considerations when using the Buggy

Speed and load capacity

The Croozer Kid with the Buggy Kit is intended for use as a pushchair. Pushing the Buggy faster than a walking pace is not permitted. Therefore, the Buggy may not be used for skating or jogging.



WARNING!

The Buggy is not approved for jogging or skating. Jogging or skating with the Buggy could result in an accident and serious injury or death.

The Buggy has the same load capacity as the Bicycle Trailer (maximum allowable weight for passengers and cargo). See page 27 for the applicable weight limits.



WARNING!

Never carry more than the maximum allowable weight. Overloading the rear cargo compartment or the optional Handlebar Console could cause the Buggy to tip backwards, resulting in serious injuries for your child.

Tip: *If you are not sure whether your Croozer Kid is overloaded, you can perform this simple test WITHOUT PASSENGERS: Depress the handlebar of the loaded Buggy by about 4 to 6 " (10 to 15 cm) to raise the Buggy wheel. Then carefully release the handlebar.*

If the Croozer Kid immediately returns to its original standing position, then the Buggy is correctly loaded. If not, e.g. if the Croozer Kid tips backwards, then the Buggy is overloaded and cannot be used.



WARNING!

Never use the handlebar for carrying loads, such as children's vehicles or bags (other than the Handlebar Console available as an accessory). Loading the handlebar could cause the Buggy to tip backwards, resulting in serious injuries for your child.

Adult supervision



WARNING!

Never leave a child in the Buggy unattended, not even briefly. In your absence, hazardous, unforeseen situations could arise.

Parking the Buggy

Only park the Buggy on flat surfaces, and always secure it with the parking brake.



WARNING!

Always set the parking brake when releasing the handlebar of the parked/stopped Stroller or Buggy, and check that the wheels are securely locked by giving the Croozer Kid a gentle push and pull. If the parking brake is not correctly engaged, the vehicle could roll into harm's way, resulting in accidents with serious injury or death.

Guidelines and tips for using the Buggy

- Check the passengers frequently to make sure they are comfortable, with adequate ventilation, and dress them appropriately. Keep in mind that, when the rain cover is attached, the passenger compartment can become warm more quickly than otherwise, especially in direct sunlight. However, in colder weather, children sitting inactively in the Buggy will feel colder than the person pushing the Buggy. Therefore, in colder temperatures,

Using your Croozer Kid

dress children in warm clothing and, if necessary, use a blanket, such as the Cosy Blanket or Bunting Bags available as accessories. You will find a list of Croozer accessories in the back of this manual.

- Never manoeuvre the Buggy over stairs or other obstacles. The jolting motion could injure your child and/or damage the Croozer Kid. Never use the Buggy on escalators.
- Always use the safety harness and ensure it is correctly adjusted to fit the child snugly and comfortably.

Special considerations when using the Stroller

Speed and load capacity

The Croozer Kid with the Stroller Kit is intended for use as a fixed-wheel stroller. Pushing the Stroller faster than a walking pace is not permitted. Therefore, the Stroller may not be used for skating or jogging. The difference between the Buggy and the Stroller is that the Stroller is easier to push and control over longer distances because of its fixed-wheel design. Therefore, it is an ideal stroller for touring on foot and walking as a sport.



WARNING!

The Stroller is not approved for jogging or skating. Jogging or skating with the Stroller could result in an accident and serious injury or death.

The Stroller has the same load capacity as the Bicycle Trailer (maximum allowable weight for passengers and cargo). See page 27 for the applicable weight limits.



WARNING!

Never carry more than the maximum allowable weight. Overloading the rear cargo compartment or the optional Handlebar Console could cause the Stroller to tip backwards, resulting in serious injuries for your child.



WARNING!

Never use the handlebar for carrying loads, such as children's vehicles or bags (other than the Handlebar Console available as an accessory). Loading the handlebar could cause the Stroller to tip backwards, resulting in serious injuries for your child.

Adult supervision



WARNING!

Never leave a child in the Stroller unattended, not even briefly. In your absence, hazardous, unforeseen situations could arise.



Tip: *If you are not sure whether your Croozer Kid is overloaded, you can perform this simple test WITHOUT PASSENGERS: Depress the handlebar of the loaded Stroller by about 4 to 6" (10 to 15 cm) to raise the Stroller wheel. Then carefully release the handlebar.*

If the Croozer Kid immediately returns to its original standing position, then the Stroller is correctly loaded. If not, e.g. if the Croozer Kid tips backwards, then the Stroller is overloaded and cannot be used.

Parking the Stroller

Only park the Stroller on flat surfaces, and always secure it with the parking brake.



WARNING!

Always set the parking brake when releasing the handle-bar of the parked/stopped Stroller or Buggy, and check that the wheels are securely locked by giving the Croozer Kid a gentle push and pull. If the parking brake is not correctly engaged, the vehicle could roll into harm's way, resulting in accidents with serious injury or death.

Use the safety wrist strap

When using the Stroller, it is vitally important that you keep the safety wrist strap around your wrist at all times. Use the rubber ring to adjust the loop size to fit snugly and comfortably around your wrist. Using the safety wrist strap prevents the Stroller from getting away from you.



WARNING!

When using the Stroller, it is vitally important that you keep the safety wrist strap fastened securely around your wrist at all times. Otherwise, you could accidentally lose control of the Stroller, causing accidents with serious injury or death.

Tip: When not in use, the safety wrist strap can hang down into the rear cargo compartment.

Guidelines and tips for using the Stroller

- Never allow children to step, sit or lean on the wheel arms, e.g. when climbing in or out of the Croozer Kid.
- Check the passengers frequently to make sure they are comfortable, with adequate ventilation, and dress them appropriately. Keep in mind that, when the rain cover is attached, the passenger compartment can become warm more quickly than otherwise, especially in direct sunlight. However, in colder weather, children sitting inactively in the Stroller will feel colder than the person pushing the Stroller. Therefore, in colder temperatures, dress children in warm clothing and, if necessary, use a blanket, such as the Cosy Blanket or Bunting Bags available as accessories. You will find a list of Croozer accessories in the back of this manual.
- Never manoeuvre the Stroller over stairs or other obstacles. The jolting motion could injure your child and/or damage the Croozer Kid. Never use the Stroller on escalators.
- Always use the safety harness and ensure it is correctly adjusted to fit the child snugly and comfortably.



Transporting your Croozer Kid

The Croozer Kid can be folded to a compact size for transport.

1. Before folding, make sure the Croozer Kid is completely empty.
2. Remove, as applicable, the hitch arm, safety flag, Buggy wheel and/or Stroller Kit components.
3. Remove the handlebar and safety wrist strap. See page 13.
4. Remove the wheels. See page 12.

NOTICE

Be extremely cautious: when the Croozer Kid is lying on the ground with no wheels, the brake shoes are very susceptible to damage because the vehicle's entire weight is resting on them.

5. Fold the Croozer Kid. See also page 9.

NOTICE

When folding the Croozer Kid, never let the plastic side windows get pinched between the frame parts, as this could damage the windows.

6. Place all removed parts inside the Croozer Kid.
7. Close the cover. See page 24.
8. Thread the end of the transport safety strap through the buckle (1) to secure the folded Croozer Kid for transport. The transport safety strap is kept in a special storage pocket (2) at the top of the cover.
9. The Croozer Kid is now ready for transport in a vehicle.

NOTICE

When the wheels of the Croozer Kid are removed, the brake shoes extend from the folded frame with no protection and are therefore especially susceptible to damage. Be very cautious during transport and loading.

NOTICE

Never transport the Croozer Kid – even when folded – on the roof of a motor vehicle, as this could damage the fabric cover.

10. For air travel etc., we recommend packing the folded Croozer Kid in its original box. To do so, the brake shoes and front bumper must be removed.



Croozer Kid Inspections and Maintenance

To ensure that your Croozer Kid will have a safe, long and problem-free service life, inspections and maintenance must be performed at regular intervals. The Croozer Kid's wheels, hitch arm, frame, fabric body, security pins, quick-release mechanisms and safety harnesses must be checked periodically for damage. If any of these parts are found to be damaged, the Croozer Kid may not be used until the damage has been properly repaired.



WARNING!

Never use the Croozer Kid if it is not in perfect working order. Damaged parts could cause accidents with serious injury or death. Therefore, it is vitally important that you have your Croozer Kid serviced regularly – at least once a year – by a professional bicycle mechanic.



WARNING!

It is vitally important that the maintenance work described in this section be performed to professional standards and at the specified intervals.

Inspection intervals

Check the overall condition of the Croozer Kid periodically to identify any parts in need of repair or replacement. Some parts should be checked before each use, and others only monthly. Generally, a visual inspection is sufficient: is everything where it belongs, are there any tears in the fabric of the body, are any of the metal parts cracked or bent, are the safety harnesses intact, are the tyres in good condition and properly inflated, and, if applicable, are the accessories in perfect working order? A complete checklist for inspection is provided in the table on the right.

Service intervals

Have the Croozer Kid serviced by a professional bicycle mechanic at least once a year. The actual necessary service intervals will depend on various factors, such as weather conditions, road conditions, loading etc. If the Croozer Kid is not being used very often, then an annual service by a professional bicycle mechanic is sufficient. If the Croozer Kid is used on a daily basis, even in the winter, then we recommend having it professionally serviced more often, as the parts can wear significantly faster. Pulling the trailer with an e-bike (with electric assist) will also subject the Croozer Kid's parts to much greater wear, meaning that shorter service intervals will be necessary.

Daily	What should be done?
Visual Inspection by User	
Overall condition	Check for damaged parts
Fabric body	Check for tears etc.
Safety harnesses	Check for damage and proper function
Locking mechanisms and security pins	Check for proper function and whether securely locked
Hitch arm, hitch connector, wheel arms, Buggy wheel	Check for damage and proper installation
Attachment of side wheels	Check that the axles are locked securely in the axle receivers
Hitch-arm security pin and safety strap	Check for correct attachment
Lighting system (optional)	Check for proper function
Tyres	Check tyre pressure Check for damage or cracks
Quick-release axles with retaining balls and push-button pins (side wheels)	Clean and lubricate
Quick-release mechanism for Stroller wheel	Check for proper function and whether properly closed
Cargo weight and hitch-arm load (nose weight)	Ensure that all values are within specified limits
Safety flag on Bicycle Trailer	Check that flag is mounted
Towing bicycle	Check that towing bicycle is in perfect working order

Monthly	What should be done?
Tyres	Check tyre pressure Check for damage or cracks Check tread depth
Side wheel axles	Clean and lubricate retaining balls and push-button pins

Yearly*	What should be done?
Thorough maintenance check	Croozer must be serviced by a professional bicycle mechanic
* depending on type and frequency of use	

Inspecting the hitch arm, hitch connector, Stroller Kit components and Buggy wheel

Inspect the hitch arm, hitch connector, Stroller Kit components, Buggy wheel and their respective attachment brackets regularly for damage. If a part is cracked, dented, bent or damaged in any way, the Croozor Kid may not be used with the respective part until it has been replaced or repaired. Have all damaged parts repaired or replaced immediately by a professional bicycle mechanic. Check that the hitch nut is securely fastened.

Inspect the fabric body

Check the fabric body and the two-in-one cover regularly for damage. Small tears or holes can be repaired. In the case of irreparable damage, the fabric body must be replaced.



WARNING!

Your child may be able to reach the wheel spokes through tears or holes in the fabric, which could result in serious injuries. If you notice tears or holes in the fabric, do not use the Croozor Kid until all damage has been properly repaired or the body has been replaced.

Inspecting and servicing the wheels

The wheels should be checked for alignment (radial and lateral true) on a regular basis and retuned as necessary. An annual wheel inspection by a professional bicycle mechanic is usually sufficient.

Checking tyre pressure and treads

Check the tyre pressure before each use. The tyre pressure should be between 1.5 and 2.5 bar (22-36 P.S.I.). The inner tubes have Schrader valves, also known as car valves. You will need a pump with the appropriate nozzle. Never use compressed air, e.g. from a gas/petrol station, to fill your tyres. The quick flow and high pressure can overinflate the tyres, causing the tube and/or tyre to burst.

Inspect the tyres periodically for adequate tread depth and any signs of damage or excessive wear. Worn-out or damaged tyres can affect the handling and even burst, which could result in accidents with serious injury or death.



77

Cleaning and lubricating the wheel axles

The wheels of the Croozer Kid are equipped with a special mechanism for easy attachment and removal. The retaining balls (1) and push-button pins (2) of the axles must be cleaned and lubricated on a regular basis.



WARNING!

The retaining balls (1) and push-button pins (2) of the axles must be cleaned and lubricated on a regular basis. Otherwise, the wheel could fall off while riding, resulting in accidents with severe injury or death.

1. Wipe off the axle with a clean cloth to remove dirt and grime.
2. If any dirt or grime remains around the push-button pin or retaining balls, then clean them with a small brush.
3. Lubricate these parts, and press the push-button several times to distribute the lubricant evenly. The push-button pin and retaining balls must be able to move freely.
4. Use a clean cloth to wipe off any excess lubricant.

Tip: *The axle can be lubricated using a bicycle-chain lubricant.*



Inspecting the Croozer Kid after an accident

If the Croozer Kid has been involved in an accident, it must be inspected by a professional bicycle mechanic before it can be used again, even if there is no visible damage. Accidents can leave behind tiny, and often invisible, hairline cracks in critical components whose failure would adversely affect the safety of the vehicle.

Cleaning and Storing the Croozer Kid

How do I clean and maintain my Croozer Kid?

Fabric body

Clean the fabric body and seat with water, a soap solution or a mild household detergent. Use biodegradable cleaning agents whenever possible to minimise environmental impact. A soft brush can be used to clean areas of heavy soiling.

Never use solvents, such as mineral spirits, or other aggressive chemicals, as these can damage the fabric, seat and plastic windows. Never use pressure washers. The strong water pressure could damage the fabric and plastic windows.

Frame and other metal parts

Clean all metal parts with water, a soap solution or a mild household detergent. Use biodegradable cleaning agents whenever possible to minimise environmental impact. A soft brush can be used to clean areas of heavy soiling.

Never use solvents, such as mineral spirits, or other aggressive chemicals, as these can corrode the metal parts. Never use pressure washers. The strong water pressure can force water into the wheel bearings, shortening their service life.

To protect metal parts from corrosion, a thin coat of paste wax can be applied. Preserving metal parts with paste wax is especially important if you plan to use the Croozer Kid often in wet weather, in salty air near the sea or in the winter.

How do I store my Croozer Kid?

General information

Store your Croozer Kid, if possible, in a dry, warm and well-ventilated area. The minimum storage temperature is -4°F (-20°C); lower temperatures could cause the fabric and plastic windows to become brittle.

If you cannot store your Croozer Kid indoors, then use a waterproof cover to protect it from the rain. For this purpose, we recommend the Croozer Storage Cover, which is available as an accessory.

Avoid long-term exposure to direct sunlight, which will fade the fabric over time.

If possible, avoid using the Croozer Kid in salty air, e.g. near the sea, or during winter months on salted roads, as the salt can corrode metal parts. To protect metal parts from corrosion, apply a thin coating of paste wax to all metal surfaces.

Long-term storage

If you will not be using your Croozer Kid for an extended period of time, for example over the winter months, then prepare the vehicle for storage as follows:

1. Clean the Croozer Kid thoroughly as described above.
2. Allow the Croozer Kid to dry completely, and apply paste wax to protect the metal parts from corrosion.
3. Store the Croozer Kid in a dry, dust-free and well-ventilated room. Cover the Croozer Kid with a sheet, tarp/tarpaulin or the Croozer Storage Cover, which is available as an accessory.

NOTICE

To prevent mildew and mould growth, the Croozer Kid must be completely dry and clean before being put into storage.

Tip: *To save space, the Croozer Kid can be stored in its folded state.*

4. Inner tubes will slowly lose pressure over time. Storing the Croozer Kid on flat tyres for an extended period of time could damage the tyres. Therefore, if you plan to store the Croozer Kid several weeks or months, it should be either hung from the wall or ceiling or propped up with its wheels off the ground. Otherwise, check the tyre pressure periodically, and keep the tyres inflated.
5. Before using your Croozer Kid after a long period of storage – for example, if you have stored it over the winter – check that it is perfect working order, and have it serviced by a professional bicycle mechanic.

Preparing the Croozer Kid for disposal

The Croozer Kid is extremely durable and robust. However, if the vehicle must be disposed of, e.g., owing to severe damage etc., then contact your Croozer dealer, who can help you dispose of the Croozer Kid, or individual parts, in an environmentally sound manner. Furthermore, be sure to dispose of any spare parts, such as tyres, in an environmentally sound manner. In case of doubt, contact your Croozer dealer.

Tip: *The fabric of the Croozer Kid body is resistant to mould and mildew. Moulds feed off organic matter in the fabric, e.g. food residues, dirt etc. and grow best in warm, damp and humid conditions. Therefore, it is very important that you follow these storage guidelines to prevent mould growth.*

However, if you do happen to find mould or mildew on your Croozer Kid, it can be cleaned in mild cases, using a mild alcohol-based cleaning agent, 5% household vinegar or a 5% sodium bicarbonate solution. NEVER USE HARSH CHEMICAL FUNGICIDES. These chemicals are often highly toxic and could be very dangerous to your child's health. For severe cases of mould or mildew, the fabric body must be replaced. Contact a Croozer dealer.

Technical Data

Dimensions of Open Chassis (Without Hitch Arm) L x W x H	
Croozer Kid for 1	43 x 29 x 33 inch (110 x 74 x 84 cm)
Croozer Kid for 2	44.5 x 35.5 x 33 inch (113 x 90 x 84 cm)
Dimensions of Folded Chassis (Without Wheels) L x W x H	
Croozer Kid for 1	40.5 x 29 x 11 inch (103 x 74 x 27.5 cm)
Croozer Kid for 2	41 x 34 x 11 inch (104.5 x 86.5 x 27.5 cm)
Weight of Empty Chassis with Wheels and Handlebar	
Croozer Kid for 1	34.2 lbs (15.5 kg)
Croozer Kid for 2	37.25 lbs (16.9 kg)
Maximum Weight of Loaded Trailer (Trailer + Passengers + Cargo)	
Croozer Kid for 1	100 lbs (45 kg), max. 1 child
Croozer Kid for 2	132 lbs (60 kg), max. 2 children
Cargo Capacity *	
Rear cargo compartment	max. 11 lbs (5 kg)
Handlebar Console (accessory)	max. 4.4 lbs (2 kg)
Max. Weight of Passengers	
Croozer Kid for 1	33 lbs (15 kg)
Croozer Kid for 2	2 x 33 lbs (2 x 15 kg)
Maximum Height of Passengers	
	46 inch (117 cm)
Minimum Age of Passengers	
Without Infant Sling	6 months (if the child can sit upright unassisted)
With Infant Sling (accessory)	1 month
Maximum Age of Passengers	
Without Infant Sling	6 years
With Infant Sling (accessory)	10 months
Wheel/Tyre Size, Chassis	
	20", 47- 406 (20 x 1,75 inch)
Recommended Tyre Pressure	
	1,5 - 2,5 bar (30 - 35 P.S.I.)
Wheel/Tyre Size, Stroller Wheel	
	16", 47- 305 (16 x 1,75 inch)
Valves	
	Schrader (car valve)
Wheel Size, Buggy Wheel	
	8"
* Weight limits only apply if the hitch-arm load is within the specified range of 6.6 to 17.6 lbs (3-8 kg). See page 27.	

Accessories

Several accessories are available for even more comfortable Croozing. Accessories can be purchased from any Croozer dealer.

Sun Cover

A practical sunshade for your child. Available in Croozer Kid colours: one-seater (ice blue) and two-seater (peppermint green)



79

Rain Cover

For one-seater or two-seater



85

Handlebar Console

For one-seater (ice blue) or two-seater (peppermint green)



80

Storage Cover

Grey, waterproof



86

Baby Supporter

For small children aged approx. 10 to 18 months, height adjustable, 2-part



81

All Season Bunting Bag

For babies and toddlers, fleece seat liner and bunting bag for all seasons



87

Infant Sling

For babies aged 1 to 10 months



82

Cosy Blanket

Polar fleece, graphite, ideal for use with Infant Sling



88

Baby Winter Bunting Bag

For babies, dark grey outer shell, light grey cotton-fleece liner, ideal for Infant Sling



83

Foot Mat

For the Croozer Kid, one size fits all



89

Toddler Winter Bunting Bag

For small children, black outer shell, light grey cotton-fleece liner



84

Hitch Nut Adapter

Allows you to use the hitch nut with various bicycle axles



90

Warranty

The statutory warranty in the country or state of purchase has unlimited application to the above-mentioned products. This warranty only applies to defects inherent to the material supplied and does not cover damage due to improper use, use of force, lack of maintenance or normal wear and tear. The period of statutory warranty depends on the law of the country in question.

Our products have parts and components that, even with normal use, are subject to natural wear and tear; the rate of wear, however, will depend very much on the type and intensity of use, as well as the respective level of care and maintenance.

Therefore, individual parts or components may reach their wear limits before the end of the statutory warranty period, especially if the product has been used intensively (daily use in any weather, the use of a towing bicycle with electric assist etc.). In such cases, premature wear is caused by the product's use and does not represent a defect in the sense of the warranty.

The rate at which parts will reach their wear limits depends very much on the type and intensity of use, the level of care and maintenance, and the following factors:

- mileage
- loading:
 - passengers
 - cargo
- riding style:
 - harshness of acceleration and braking
- high-speed turning
- weather and environmental factors:
 - UV radiation
 - moisture and humidity
 - soiling/dirt/dust
 - temperature
 - salty air
 - contact with salt water
 - road salt
- storage
- maintenance status:
 - service intervals
 - use of maintenance products
 - maintenance work and inspections

Servicing and warranty claims

If any part of the Croozer Kid is not working properly, if the vehicle requires servicing or to make a warranty claim, contact the dealer from whom you purchased your Croozer Kid. The dealer will either help you directly or forward your claim to us. In order to process your claim, we – and/or your dealer – will need the original sales receipt and the serial number of your Croozer Kid.

The serial number can be found on the sticker that is affixed to the bottom of the black frame on the left side of the cargo compartment.

Distributors

For a list of distributors, visit our website at www.croozer.eu.



CONTACT

Zwei plus zwei GmbH
Oskar-Jäger-Straße 125
D-50825 Cologne
Germany
info@zweipluszwei.com
www.croozer.eu

The logo for CROOZER, featuring the word "CROOZER" in a bold, italicized, sans-serif font. The letters are black with a white outline and a drop shadow effect, giving it a three-dimensional appearance.